



S U P E R  
DIGITAL INVERTER



## DX Air Curtain (EC) Installation and Owner's manual

Model name:

For commercial use

**RAV-CT101/151/201/251BH-M/L** DX Air Curtain (EC) Built-in (Medium / Large)

**RAV-CT101/151/201/251CH-M/L** DX Air Curtain (EC) Free-Hanging (Medium / Large)

**RAV-CT101/151/201/251UH-M/L** DX Air Curtain (EC) Cassette (Medium / Large)

**ENGLISH**

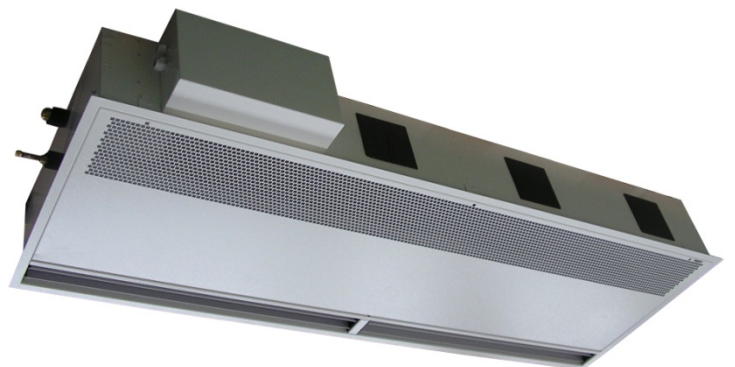

Please read this Installation Manual carefully before installing the DX Air Curtain.

- This Manual describes the installation method of the DX Air Curtain.
- You must also refer to the Installation Manual attached to the Toshiba outdoor unit.

## ADOPTION OF R410A REFRIGERANT

This Air Conditioner is a type which adopts a HFC refrigerant (R410A) instead of the conventional refrigerant R22 in order to prevent destruction of the ozone layer.

This appliance is for commercial use only and should not be accessible to the general public. This appliance is not intended for use by person (including children) with reduced physical, sensory or mental capabilities, or lack of experience and knowledge, unless they have been given supervision or instruction concerning use of the appliance by a person responsible for their safety. Children should be supervised to ensure that they do not play with the appliance.

## Contents

1	INSTALLER: APPLICATION	2
2	INSTALLER: PRECAUTIONS FOR SAFETY	3
3	INSTALLER: INSTALLATION	3
4	INSTALLER: ELECTRICAL WORK	6
5	INSTALLER: APPLICABLE CONTROLS	9
6	INSTALLER: TEST RUN	15
7	INSTALLER: TROUBLE SHOOTING	16
8	INSTALLER: MAINTENANCE GUIDELINES	19
9	INSTALLER: OPTIONAL PARTS	20
10	INSTALLER: TECHNICAL SPECIFICATIONS	21
11	INSTALLER: TECHNICAL DRAWINGS	22
12	INSTALLER: DECLARATION OF CONFORMITY	25
13	INSTALLER: SERVICE PARTS	26
14	OWNER: PRECAUTIONS FOR SAFETY	27
15	OWNER: REMOTE CONTROLLER	28
16	OWNER: CORRECT USAGE	31
17	OWNER: TIMER OPERATION	33
18	OWNER: MAINTENANCE	34
19	OWNER: AIR CONDITIONER OPERATIONS AND PERFORMANCE	36



This symbol mark is for EU countries only. This symbol mark is according to the directive 2002/96/EC Article 10 Information for users and Annex IV.

This product is designed and manufactured with high quality materials and components which can be recycled and reused.

This symbol means that electrical and electronic equipment, at the end-of-life, should be disposed of separately from your household waste.

Please dispose of this equipment at your local community waste collection / recycling centre.

In the European Union there are separate collection systems for used electrical and electronic product.

# 1 APPLICATION

Every air curtain is manufactured conforming with European directives and the latest standards. Air curtains prevent air currents and draughts and produce a comfortable environment in the door entrance area

The air curtains are manufactured to the latest technical standards and regulations. The quality controls include material and function controls and ensure a quality product with a long life span.

The air curtains are built to CE guide lines.

The fan-motors used in the Air Curtain comply with ErP 2015 (Commission Regulation (EU) No 327/2011).

Correct installation is of paramount importance. This includes that unit and control are also used in the correct environment. The air curtains and controls are manufactured for indoor use only.

Do not install in humid, aggressive or explosive areas. During the installation the unit has to be kept clean and dry.

## Applications:

DX Air curtains are only applicable:-

For indoor areas (shops, warehouses, exhibition halls, or banks, etc.)

Installed in false ceilings or free hanging

DX Air curtains must not be installed:-

In humid areas like swimming pools

Areas with danger of explosion

Areas with aggressive air

Areas with extreme high dust exposure

Vertically (Only horizontally hung installations are permitted)

## Twin / Triple Restriction:

To ensure reliable operation DX Air Curtains must be connected to a single outdoor unit (no twin or triple installations).

## Model Range:

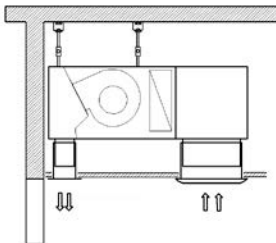

### Built-in unit (BH)

Suitable for installation in the ceiling space above the door, only the inlet grille and discharge outlet will be visible.

Door widths: 1.0m, 1.5m, 2.0m and 2.5m

2 versions offered: Medium (Door height range: 2.5m to 3.0m)  
Large (Door height range: 2.7m to 3.2m)

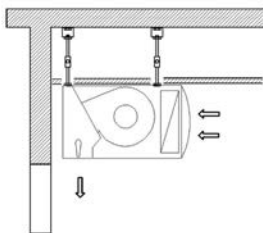

### Free-Hanging unit (CH)

Suitable for installation above the door, where whole unit will be visible.

Door widths: 1.0m, 1.5m, 2.0m and 2.5m

2 versions offered: Medium (Door height range: 2.5m to 3.0m)  
Large (Door height range: 2.7m to 3.2m)

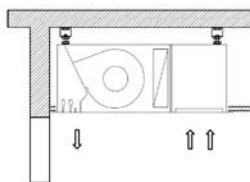

### Cassette unit (UH)

Suitable for installation where the ceiling space is limited above the door, the full panel will be visible.

Door widths: 1.0m, 1.5m, 2.0m and 2.5m

2 versions offered: Medium (Door height range: 2.5m to 3.0m)  
Large (Door height range: 2.7m to 3.2m)

## "Air On" Temperature Limits: Minimum 15°CDB / Maximum 28°CDB

In Heating mode (reverse cycle) when the outdoor unit is producing hot gas, the DX coil in the Air Curtain is effectively the condenser. Air temperatures flowing across the coil below this level, can cause over condensing of the refrigerant. This can result in liquid being returned to the compressor which will cause a mechanical failure of the outdoor unit. Low air temperatures will also cause the unit to use it's defrost mode more often

## 2 PRECAUTIONS FOR SAFETY

- Ensure that all Local, National and International regulations are satisfied.
- Read this "PRECAUTIONS FOR SAFETY" carefully before installation.
- The precautions described below include the important items regarding safety. Observe them without fail.
- After the installation work, perform a trial operation to check for any problem.
- Follow the installation manual to explain how to use and maintain the unit to the customer.
- Turn off the main power supply switch (or breaker) before the unit maintenance.
- Ask the customer to keep the installation manual.

### CAUTION

#### Refrigerant (R410A) Air Conditioner Installation

- **THIS AIR CONDITIONER ADOPTS THE HFC REFRIGERANT (R410A) WHICH DOES NOT DESTROY OZONE LAYER.**

The characteristics of R410A refrigerant are; easy to absorb water, oxidizing membrane or oil, and its pressure is approx. 1.6 times higher than that of refrigerant R22. Accompanied with the new refrigerant, refrigerating oil has also been changed. Therefore, during installation work, be sure that water, dust, former refrigerant, or refrigerating oil does not enter the refrigerating cycle.

To prevent charging an incorrect refrigerant and refrigerating oil, the sizes of connecting sections of charging port of the main unit and installation tools are changed from those of conventional refrigerant.

Accordingly the exclusive tools are required for the new refrigerant (R410A).

For connecting pipes, use new and clean piping designed for R410A, and please care so that water or dust does not enter. Moreover, do not use the existing piping because there are problems with the pressure-resistance force and impurity in it.

### CAUTION

#### To Disconnect the Appliance from Main Power Supply

This appliance must be connected to the main power supply by means of a switch with a constant separation of at least 3mm.

## 3 INSTALLATION

### POSITIONING OF THE AIR CURTAIN

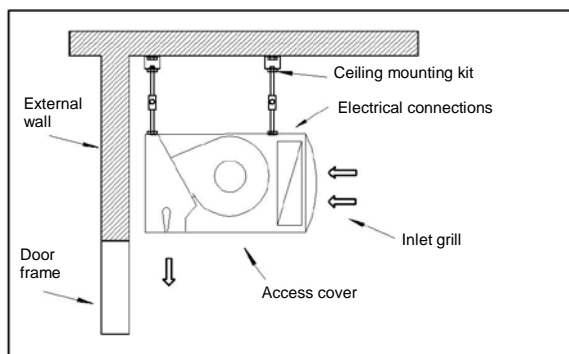

The unit should be installed as close as possible to the wall and as flush as possible to the top of the door.

The outlet flow should always be free and not interrupted or obstructed.

Don't exceed the recommended installation height recommended per type. Type plate can be found on the inside of the access panel.

### Installation height

Type	Door Height Range
M (Medium)	2.5 – 3.0 m
L (Large)	2.7 – 3.2 m

- DO NOT STAND UNDERNEATH THE UNIT WHILE LIFTED OR DURING INSTALLATION
- DO ONLY USE APPROPRIATE TOOLS FOR LIFTING AND INSTALLING
- FOLLOW ALL LOCAL RULES AND REGULATIONS

**The access panel and E-Box cover has to be accessible at all times!**

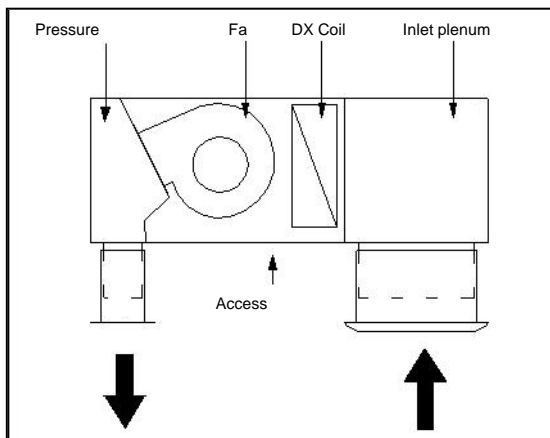

In all situations the accessibility of the unit over the whole length of the unit has to be ensured.

Please refer to the technical drawings for dimensions.

For installation within a ceiling void it has to be ensured that the access panel between in and outlet grille is accessible over the whole length of the unit.

The sliding type (BH) sections have to be fixed at the desired height (use methods suitable to avoid vibrations).

**CEILING MOUNTING**

Please use the fixing points. The number of fixing points depends on model and length of the air curtain.

Model (RAV-)	Built-in (BH) Free-Hanging (CH)				Cassette (UH)			
	CT101	CT151	CT201	CT251	CT101	CT151	CT201	CT251
<b>Fixing points</b>	1.0m	1.5m	2.0m	2.5m	1.0m	1.5m	2.0m	2.5m
<b>4</b>	M	M	M	-	M	M	M	-
	L	L	L	-	L	L	L	-
<b>6</b>	-	-	-	M	-	-	-	M
	-	-	-	L	-	-	-	L

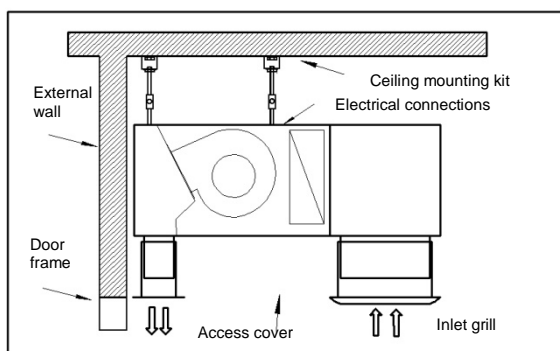

**Built-in (BH)**

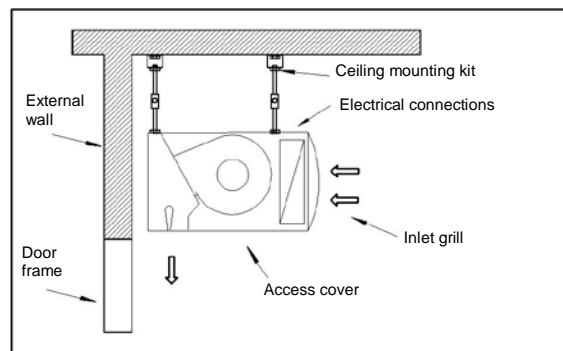

**Free-Hanging (CH)**

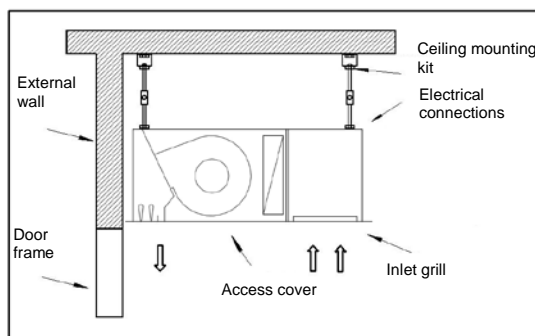

**Cassette (UH)**

**FLARE NUT CONNECTION**

The Air Curtain is fitted with R410A Flare Nuts and is charged with Nitrogen Gas (1 barg) when shipped.

Please refer to the installation Manual attached to the Toshiba Outdoor unit for flare nut instructions.

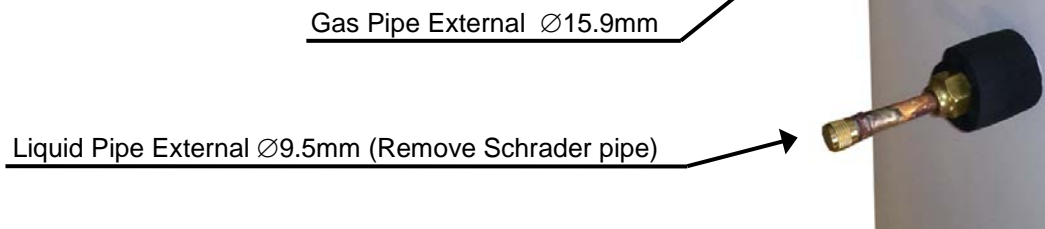

**OPTIONAL CEILING MOUNTING KIT**

Ceiling mounting kit with vibration absorber and sound insulation bracket:-

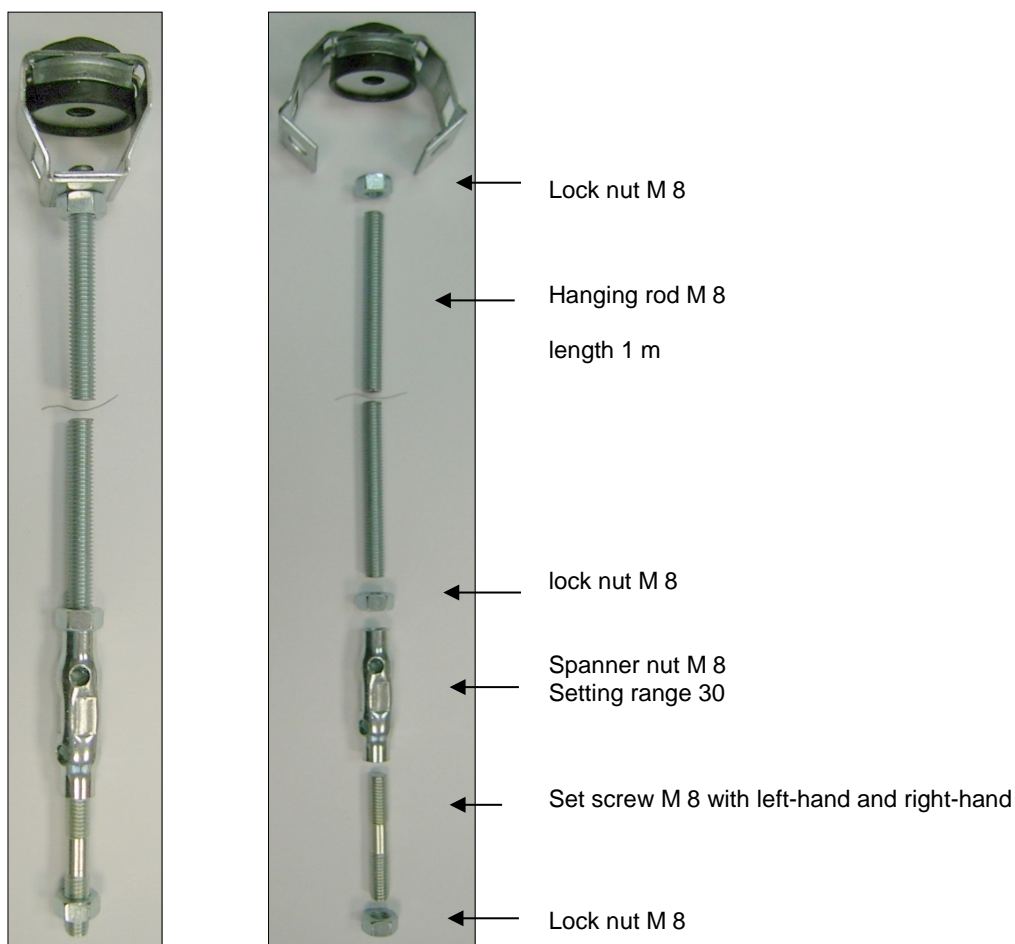

CODE	DESCRIPTION	DETAILS
3871	Ceiling mounting kit (1,0m / 1,5m / 2,0m)	M8 x 4
4034	Ceiling mounting kit (2,5m)	M8 x 6

**Wall plugs are not included in the delivery!**

When choosing the wall plug, please refer to the weight of the unit and the certification of the material

When assembling the spanner nut, please make sure that all hanging rods and set screws are properly fitted together. All parts must be countered with a lock nut.



## 4 ELECTRICAL WORK

### WARNING

1. **Using the specified wires, ensure to connect the wires, and fix wires securely so that the external tension to the wires do not affect the connecting part of the terminals.**  
Incomplete connection or fixation may cause a fire, etc.
2. **Be sure to connect earth wire (grounding work).**  
Incomplete grounding cause an electric shock.  
Do not connect ground wires to gas pipes, water pipes, lightning rods or ground wires for telephone wires.
3. **Appliance shall be installed in accordance with national wiring regulations.**  
Capacity shortage of power circuit or incomplete installation may cause an electric shock or a fire.

### CAUTION

- This indoor unit has no power cord.
- If incorrect / incomplete wiring is carried out, it will cause an electrical fire or smoke.
- Install an earth leakage breaker.  
If an earth leakage breaker is not installed, an electric shock may be caused.
- Be sure to use the cord clamps attached to the product.
- Do not damage or scratch the conductive core and inner insulator of power and inter-connecting wires when peeling them.
- Use the power cord and inter-connecting wire of specified thickness, type and protective devices required

### REQUIREMENT

- For power supply wiring, strictly conform to the Local Regulation for each country.
- For wiring of power supply of the outdoor units, follow the Installation manual of each outdoor unit.
- Never connect 220-240V power to the terminal blocks ( A, B, etc) for control wiring (otherwise the system will fail).
- Perform the electric wiring so that it does not come in to contact with the high-temperature part of the pipe.  
The coating may melt in an accident
- After connecting wires to the terminal blocks, be sure to leave sufficient wire before fixing with the cord clamp.
- Run the refrigerant piping and control wiring line in the same line.

- Do not turn on the power of the indoor unit until vacuuming of the refrigerant pipes is completed.

### Remote controller wiring

2-core non polarity wire is used for the remote controller wiring.

### How to wire

1. Connect the wires from the terminal block on the outdoor unit to the same numbered terminal on the DX Air Curtain terminal block. Use wires to H07 RH-F or 60245 IEC 66 (1.5mm<sup>2</sup> or more).
2. In the case of unsheathed redundant cords (conductors) be sure to insulate with electrical insulation tape.  
Fix them so that they do not touch any electrical or metal parts.

### REQUIREMENT

- Be sure to connect the wires matching the terminal numbers. Incorrect connection causes a trouble.
- Be sure to pass the wires through the bushing of the wiring connection port of the DX Air Curtain.
- Keep a margin (approx. 100mm) on a wire to hang down the electrical parts box at servicing, etc.
- The low-voltage circuit is provided for the remote controller (**Do not connect the high-voltage circuit**).

### Wiring

1. Remove the E-Box cover on the DX Air Curtain.
2. Strip wire ends (10mm).
3. Connect the wires from the terminal block on the outdoor unit to the same numbered terminal on the DX Air Curtain terminal block.
4. Connect the ground wires to the corresponding terminals.
5. Replace the E-Box cover on the LC DX Air Curtain.

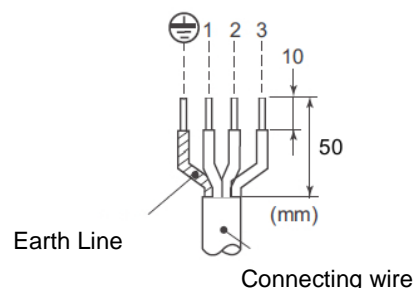

**Remote controller wiring**

- 2-core with non-polarity wire is used for wiring of the remote controller wiring and group remote controllers wiring (0.5mm<sup>2</sup> to 2.0mm<sup>2</sup>)
- Strip off approx. 9mm the wire to be connected.

Remote controller wiring. Remote controller inter-unit wiring		Wire size: 0.5mm <sup>2</sup> to 2.0mm <sup>2</sup>
Total wire length of remote controller wiring and remote controller inter-unit wiring = L + L1 + L2 + .....Ln	In case of wired type only	Up to 500m
	In case of wireless type included	Up to 400m
Total wire length of remote controller inter-unit wiring = L1 + L2 + .....Ln		Up to 200m

**CAUTION**

The remote controller wire (communication line) and AC220-240V wires cannot be parallel to contact each other and cannot be stored in the same conduits. If doing so, a trouble may be caused on the control system due to noise, etc.

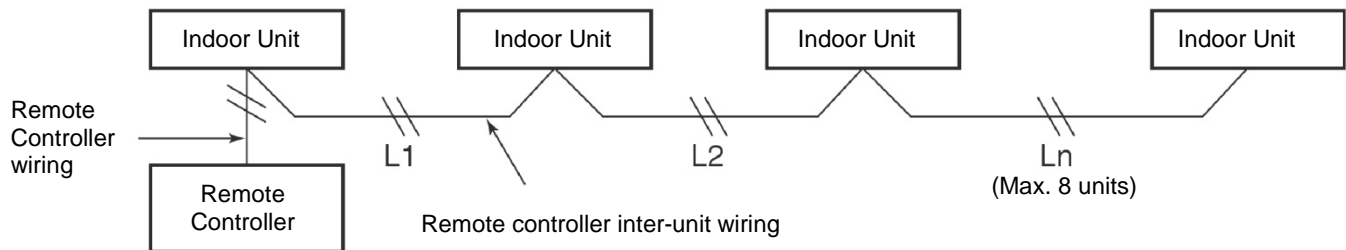

**Wiring between indoor and outdoor units**

▼ **Single phase outdoor unit**

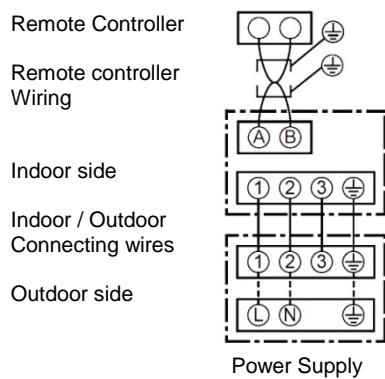

▼ **Three phase outdoor unit**

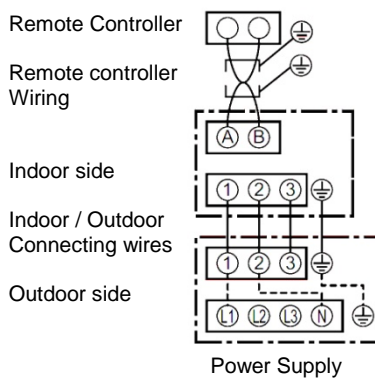

**Remote controller wiring**

- As the remote controller wire has non-polarity, there is no problem if connections to indoor unit terminal blocks A and B are reversed.

▼ **Wiring diagram**

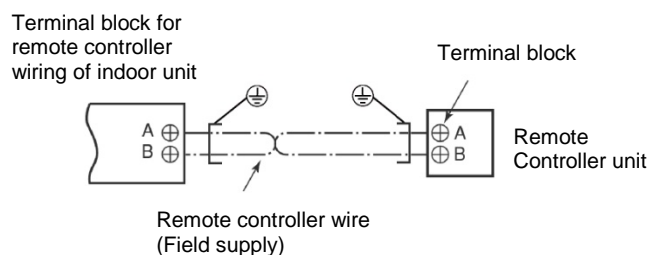



■ WIRING DIAGRAM

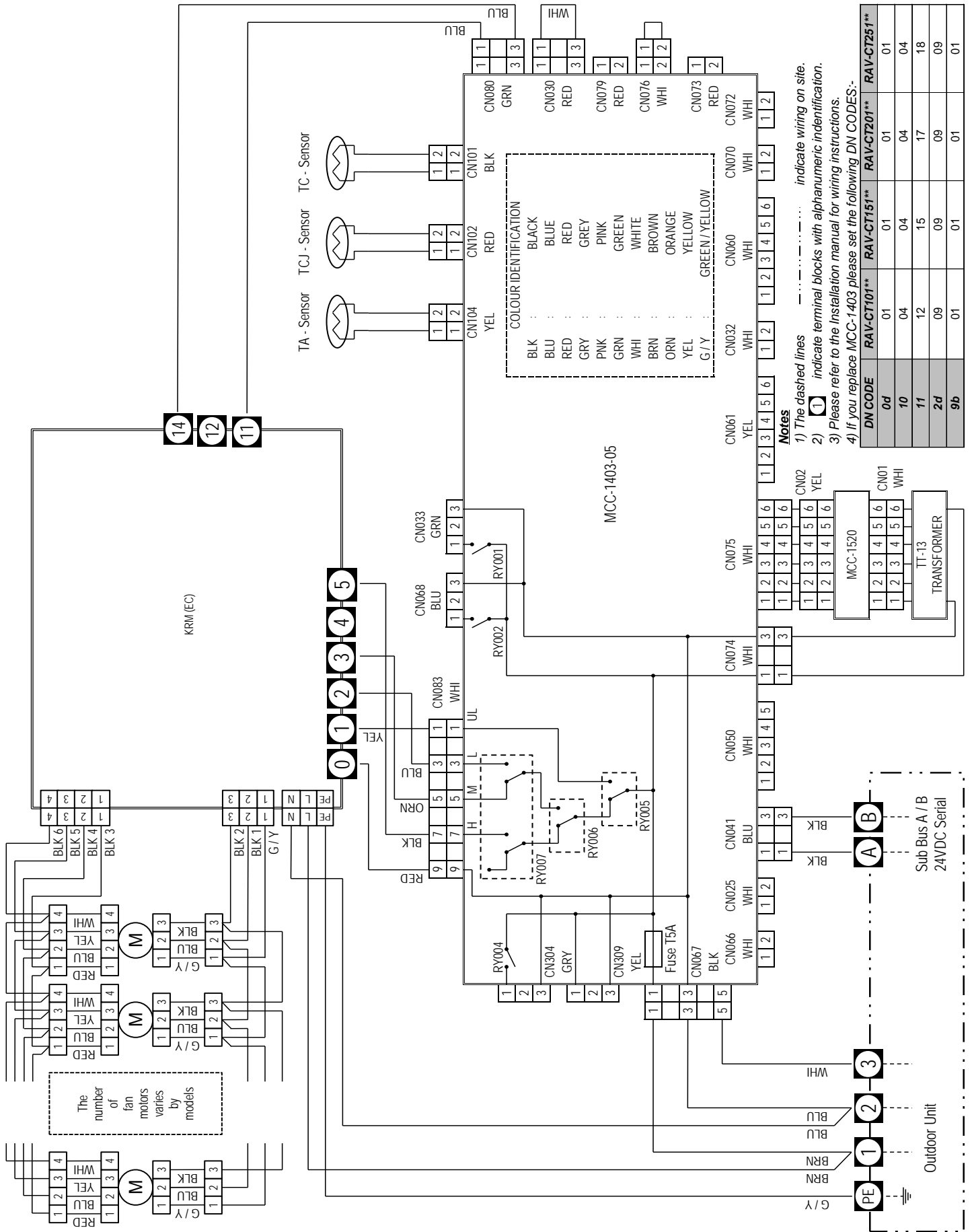

# 5 APPLICABLE CONTROLS

## REQUIREMENT

- When you use this air conditioner for the first time, it takes approx. 5 minutes until the remote controller becomes available after power-on. This is normal.

### <When the power is turned on for the first time after installation>

It takes **approx. 5 minutes** until the remote controller becomes available.

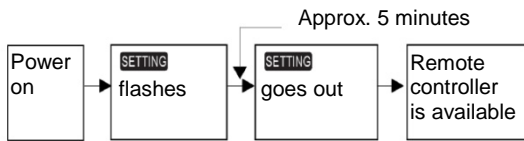

### <When the power is turned on for the second (or later) time>

It takes **approx. 1 minute** until the remote controller becomes available.

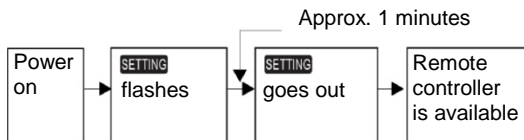

- Normal settings were made when the unit was shipped from factory. Change the indoor unit as required.
- Use the wired remote controller to change the settings.
- The settings cannot be changed using the wireless remote controller, sub remote controller, or remote controller-less system (for central remote controller only). Therefore, install the wired remote controller to change the settings.

## ■ Changing of settings for applicable controls

### Basic procedure for changing settings

Change the settings while the air conditioner is not working.  
(Be sure to stop the air conditioner before making settings).

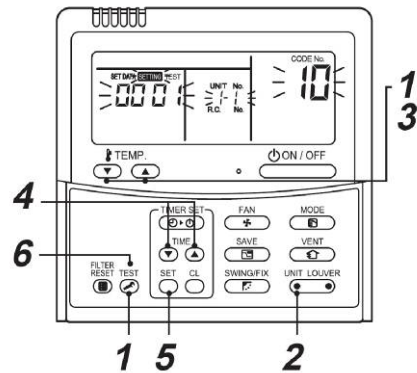

### Procedure 1

Push **SET** + **CL** + **TEST** buttons simultaneously for at least 4 seconds.

After a while, the display flashes as shown in the figure.

Confirm that the CODE No. is [10].

- If the CODE No. is not [10] push **TEST** button to erase the display content and repeat the procedure from the beginning. (No operation of the remote controller is accepted for a while after **TEST** button is pushed). (While air conditioners are operated under the group control, "ALL" is displayed first. When **UNIT LOUVER** is pushed, the indoor unit number displayed following "ALL" is the header unit).

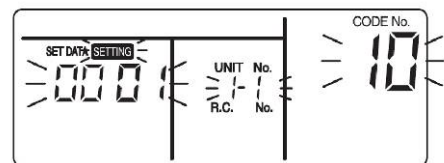

(\* Display content varies with the indoor unit model).

**Procedure 2**

Each time you push  button, indoor unit numbers in the control group change cyclically. Select the indoor unit you want to change settings for. The fan of the selected unit runs and the louvers start swinging. You can confirm the indoor unit for which you want to change settings.

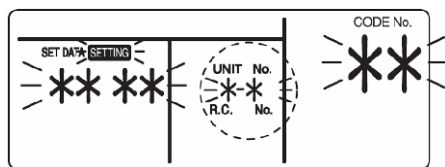
**Procedure 3**

Using "TEMP",  /  buttons, specify CODE NO. [\*\*].

**Procedure 4**

Using timer "TIME"  /  buttons, select SET DATA [\*\*\*\*].

**Procedure 5**

Push  button. When the display changes from flashing to lit, the setup is completed.

- To change settings of another indoor unit, repeat from procedure 2.
- To change other settings of the selected indoor unit, repeat from procedure 3.

Use  button to clear the settings.

To make settings after  button was pushed, repeat from procedure 2.

**Procedure 6**

When settings have been completed, push  button to determine the settings.

When  button is pushed, **SETTING** flashes and then the display content disappears and the air conditioner enters the normal stop mode.

(While **SETTING** is flashing, no operation of the remote controller is accepted).

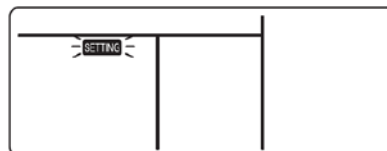

### DX Air Curtain Configuration

The circuit board of the DX AIR CURTAIN is configured at the factory. For reference these are the settings used. Any changes must be set using the DN code menu.

Follow to the basic operation procedure (1 → 2 → 3 → 4 → 5 → 6).

DN CODE	DX AIR CURTAIN MODEL (RAV-****-M/L)	CT101BH/CH/UH	CT151BH/CH/UH	CT201BH/CH/UH	CT251BH/CH/UH
01	DIRTY FILTER ALARM (Disabled)		0000		
03	CENTRAL CONTROL ADDRESS (Unset)		0099*		
0d	AUTO MODE (Disabled)		0001		
10	DEVICE TYPE		0004		
11	CAPACITY CODE	0012	0015	0017	0018
12	POWER ADDRESS (Unset)		0099*		
13	DEVICE ADDRESS (Unset)		0099*		
14	GROUP ADDRESS (Unset)		0099*		
2d	AVAILABLE MODE (Heating & Fan Only)		0009		
9b	FAN CONTROL (Disabled)		0001 (Fan motor operates during defrost cycle) (To stop fan motor operation during defrost cycle change to 0000)		

\* 0099 = address not assigned (system addresses are assigned during the automatic addressing by the system. Central addresses can be assigned automatically with a central remote control or manually. Subsequent modifications may lead to malfunction.)

## ■ To secure better effect of heating

When it is difficult to obtain satisfactory heating due to installation place of the indoor unit or structure of the room, the detection temperature of heating can be raised. Also use the circulator, etc. to circulate heat air near the ceiling.

Follow to the basic procedure

(1→2→3→4→5→6).

- For the CODE No. in Procedure 3, specify [06].
- For the set data in Procedure 4, select the setup data of shift value of detection temperature to be set up from the table below.

Setup Data	Detection temp shift value
0000	No shift
0001	+1°C
0002	+2°C (at shipment from factory)
0003	+3°C
0004	+4°C
0005	+5°C
0006	+6°C

## ■ Group Control

### In case of group control for system of multiple units.

One remote controller can control maximum 8 indoor units as a group.

### ▼ In case of group control in single system.

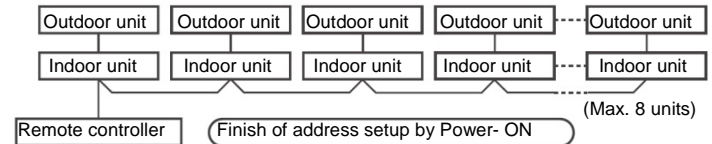

- For wiring procedure and wiring method of the individual line (Identical refrigerant line) system, follow to "Electrical work".
- Wiring between lines is performed in the following procedure.  
Connect the terminal block (A/B) of the indoor unit connected with a remote controller to the terminal blocks (A/B) of the indoor units of other indoor units by wiring the inter-unit wire of the remote controller.
- When the power supply has been turned on, the automatic address setup starts and which indicates that address is being set up on the display part. during setup of automatic address, the remote controller operation is not accepted.

**Required time up to the finish of automatic addressing is approx. 5 minutes.**

### **NOTE**

In some cases, it is necessary to change the address manually after setup of the automatic address according to the system configuration of the group control.

**Group Control procedure example**

**Manual address setup procedure**

While the operation stops, change the setup.  
(Be sure to stop operation of the unit).

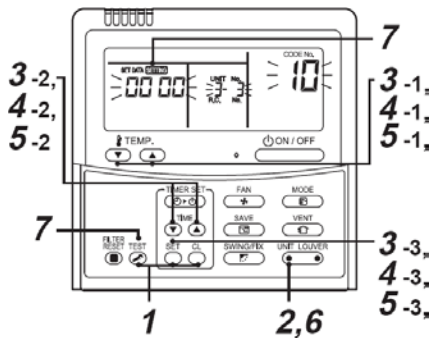

**Procedure 1**

Push simultaneously **SET** + **CL** + **TEST** buttons for 4 seconds or more. After a while, the display part flashes as shown below. Check the displayed CODE No. is [10].

- When the CODE No. is other than [10], push **TEST** button to erase the display and repeat procedure from the first step.  
(After pushing **TEST** button, operation of the remote controller is not accepted for approx. 1 minute).  
(For group control, No. of the first displayed indoor unit becomes the header unit).

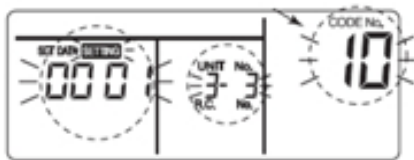

(\* Display changes according to the model No. of indoor unit.)

**Procedure 2**

Every pushing **UNIT LOUVER** button, the indoor unit No. in the group control is displayed in order. Select the indoor unit of which setup is changed. In this time, the position of the indoor unit of which setup is changed can be confirmed because fan of the selected indoor unit operate.

**Procedure 3**

1. Using temp. setup **▼** **▲** buttons, specify CODE No. [12].  
(CODE No. [12]: Line address).
2. Using timer time **▼** **▲** buttons, change the line address from [3] to [2].
3. Push **SET** button.  
In this time, the setup finishes when the display changes from flashing to lighting.

Indoor unit No. before setup change is displayed.

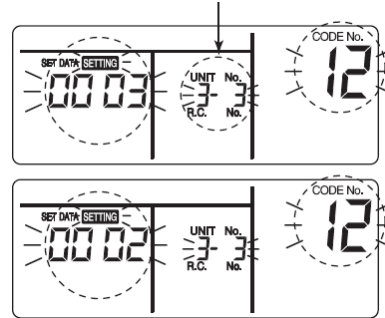

**Procedure 4**

1. Using temp. setup **▼** **▲** buttons, specify CODE No. [13].  
(CODE No. [13]: Indoor address)
2. Using timer time **▼** **▲** buttons, change the indoor address form [3] to [2].
3. Push **SET** button.  
In this time, the setup finishes when the display changes from flashing to lighting.

Indoor unit No. before setup change is displayed

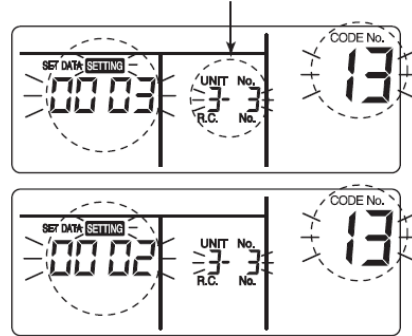

**Procedure 5**

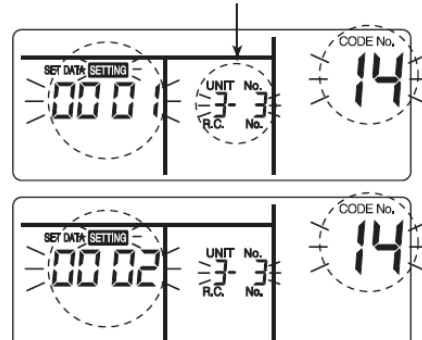

1. Using temp. setup **▼** **▲** buttons, specify CODE No. [14].  
(CODE No. [14]: Group address).
2. Using timer time **▼** **▲** buttons, change the setup data from [0001] to [0002].  
(Setup data [Header unit: 0001] [Follower unit: 0002])
3. Push **SET** button.  
In this time, the setup finishes when display changes from flashing to lighting.

Indoor unit No. before setup change is displayed



**Procedure 6**

If there is other indoor unit to be changed, repeat procedure 2 to 5 to change the setup.

When the above setup has finished, push  to select the indoor unit No. before change of setup, specify CODE No. [12], [13], [14] in order with temp. setup   buttons, and then check the changed contents.



Address change check before change: [3-3-1] → After change [2-2-2].

Pushing  button clears the contents of which setup was changed. (In this case, procedure from 2 is repeated).

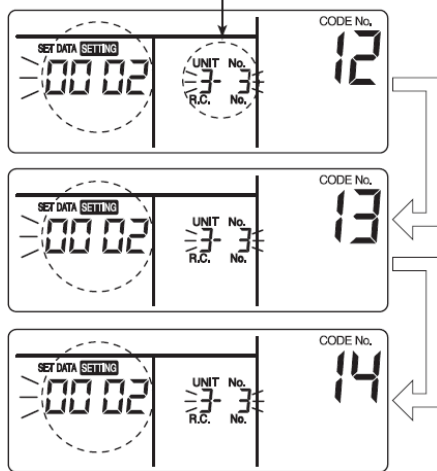
Indoor unit No. before setup change is displayed



**Procedure 7**

After check of the changed contents, push  button, the display disappears and the status becomes the usual stop status. (When pushing  button the operation from the remote controller is not accepted for approx. 1 minute).

- If the operation from the remote controller is not accepted even 1 minute or more passed after pushing  button, it is considered that the address setup is incorrect. In this case, the automatic address must be set again set up. Therefore repeat procedure of the setup change from procedure 1.

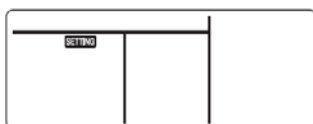

**To recognize the position of the corresponding indoor unit though the indoor unit No. is known.**

Check the position during operation stop. (Be sure to stop operation of the set).

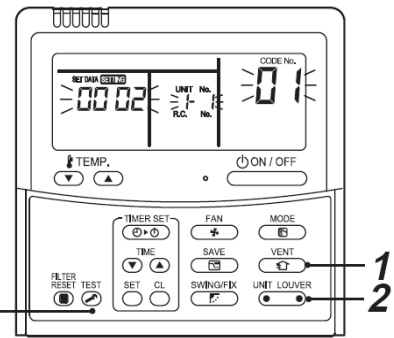



**Procedure 1**

Push simultaneously  +  buttons for 4 seconds or more.

After a while, the display part flashes and the display appears as shown below.

In this time, the position can be checked because fan of the indoor unit operate.

- For the group control, the indoor unit No. is displayed as [ALL] and fans of all the indoor units in the group control operate. Check the display CODE No. is [01].
- When the CODE No. is other than [01], push  button to erase the display and repeat procedure from the first step. (After pushing  button, operation of the remote controller is not accepted for approx. 1 minute).

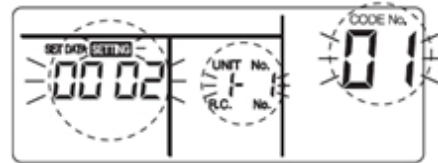

(\* Display changes according to the model No. of indoor unit.)

**Procedure 2**

In the group control, every pushing  button, the indoor No. in the group control is displayed in order.

In this time, the position of the indoor unit can be confirmed because the only fan of the selected indoor unit operate.

(For a group control, No. of the firstly displayed indoor unit becomes the header unit).

**Procedure 3**

After confirmation, push  button to return the mode to the usual mode.

When pushing the  button, the display disappears and the status becomes the usual stop status.

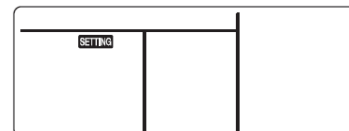

(When pushing  button the operation from the remote controller is not accepted for approx. 1 minute).









## ■ Remote controller switch monitoring function

This function is available to call the service monitor mode from the remote controller during a test run to acquire temperatures of sensors of the remote controller, indoor unit and outdoor unit.

1. Push  and  buttons simultaneously for at least 4 seconds to call the service monitor mode.

The service monitor indicator lights up and the header indoor unit number is displayed first. CODE No.  is also displayed.

2. Pushing TEMP.   buttons, select the number of sensor, etc. (CODE No.) to be monitored (see the following table).
3. Pushing  (left side of button), select an indoor unit in the group to be monitored. The sensor temperatures of indoor units and their outdoor unit in the control group are displayed.
4. Push  button to return to the normal display.

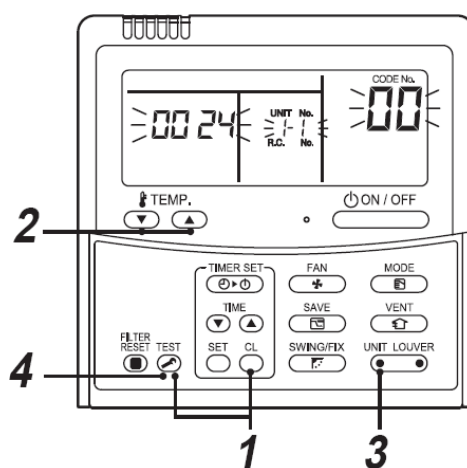

Indoor Unit Data	
CODE No.	Data Name
01	Room temperature (remote controller)
02	Indoor unit intake air temperature (TA)
03	Indoor unit heat exchanger (coil) temperature (TCJ)
04	Indoor unit heat exchanger (coil) temperature (TC)
F3	Indoor unit fan cumulative operating hours (x1 h)

Outdoor Unit Data	
CODE No.	Data Name
60	Outdoor unit heat exchanger (coil) temperature (TE)
61	Outside air temperature (TO)
62	Compressor discharge temperature (TD)
63	Compressor suction temperature (TS)
64	—
65	Heat sink temperature (THS)
6A	Operating current (x1/10)
F1	Compressor cumulative operating hours (x100h)

# 6 TEST RUN

## ■ Before test run

- Before turning on the power supply, carry out the following procedure.
  - 1) Using 500V-Megger, check that the resistance of 1MΩ or more exists between the terminal block of the power supply and the earth (grounding).  
If resistance of less than 1MΩ is detected, do not run the unit.
  - 2) Check the valve of the outdoor unit being opened fully.
- To protect the compressor at activation time, leave power-ON for 12 hours or more before operating.

## ■ How to execute a test run

Using the remote controller, operate the unit as usual.

A forced test run can be executed in the following procedure even if the operation stops by thermo-OFF.

In order to prevent a serial operation, the forced test run is released after 60 minutes have passed and returns to the usual operation.

### CAUTION

- Do not use the forced test run for cases other than the test run because it applies excessive load to the devices.

In case of wired remote controller.

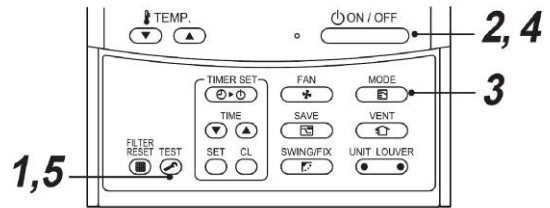

### Procedure 1

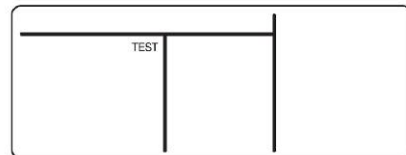

Keep  button pushed for 4 seconds or more. [TEST] is displayed on the display part and the selection of mode in the test mode is permitted.



### Procedure 2

Push  button.

### Procedure 3

Using  button, select the operation mode, [ HEAT].

- Do not run the air conditioner in a mode other than [ HEAT].
- The temperature controlling function does not work during test run.
- The detection of errors is performed as usual.

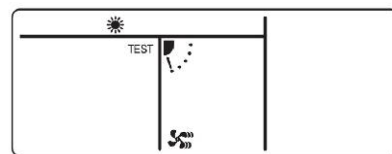

### Procedure 4

After the test run, push  button to stop a test run. (Display part is same as procedure 1).

### Procedure 5

Push  check button to cancel (release from) the test run mode. ([TEST] disappears on the display and the status returns to normal).

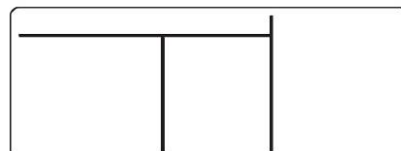

## After the TEST RUN

Please check the following after the TEST RUN of the air curtain:

- Are all functions of the control working
- Are all fans run freely

## Adapt the outlet grille to summer or winter operation

The outlet grille can be manually adjusted to 5 different positions. In winter the outlet grille needs to be adjusted outwards (Heating), in summer inwards (Fan Only). The airstreams then needs to be adjusted in a way that the air stream reaches the ground at room temperature.

### Outlet grille (examples)

 **Summer**

**Winter** 



# 7 TROUBLE SHOOTING

## Confirmation and check

When a trouble occurred in the air conditioner, the check code and the indoor unit No. appear on the display part of the remote controller.

The check code is only displayed during the operation.

If the display disappears, operate the air conditioner according to the following "Confirmation of error history" for confirmation.

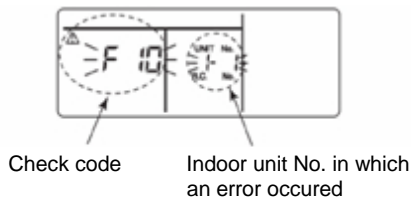



## Confirmation of error history

When a trouble occurred on the air conditioner, the trouble can be confirmed with the following procedure. (The trouble history is stored up to 4 troubles.)

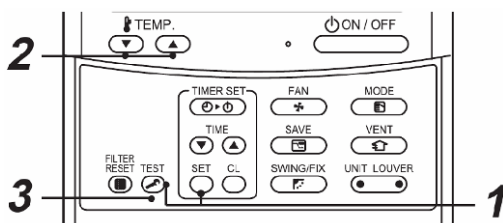
The history can be confirmed from both operating status and stop status.



### Procedure 1



When pushing  and  buttons at the same time for 4 seconds or more, the following display appears.

If [ service check] is displayed, the mode enters in the trouble history mode.

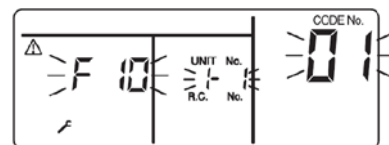
- [01: Order of trouble history] is displayed in CODE No. window.
- [Check code] is displayed in CHECK window.
- [Indoor unit address in which an error occurred] is displayed in Unit No.



### Procedure 2

Every pushing of "TEMP."   button used to set temperature, the trouble history stored in memory is displayed in order.

The numbers in CODE No. indicate CODE No. [01] (latest) → [04] (oldest).

### REQUIREMENT

Do not push  button because all of trouble history of the indoor unit will be deleted.

### Procedure 3

After confirmation, push  button to return to the usual display.

## Check codes and parts to be checked

Indication	Main defective parts	Judging device	Parts to be checked / error description	Air conditioner status
E01	No header remote controller	Remote controller	Incorrect remote controller setting --- The header remote controller has not been set (including two remote controllers).	*
	Remote controller communication error		No signal can be received from the indoor unit.	
E02	Remote controller transmission error	Remote controller	Indoor/outdoor connecting wires, indoor P.C. board, remote controller ---No signal can be sent to the indoor unit.	*
E03	Indoor unit-remote controller regular communication error	Indoor	Remote controller, network adapter, indoor P.C. board --- No data is received from the remote controller or network adapter.	Auto-reset
E04	Indoor unit-outdoor unit serial communication error	Indoor	Indoor/outdoor connecting wires, indoor P.C. board, outdoor P.C. board --- Serial communication error between indoor unit and outdoor unit	Auto-reset
	IPDU-CDB communication error			
E08	Duplicated indoor addresses ★	Indoor	Indoor address setting error --- The same address as the self-address was detected.	Auto-reset
E09	Duplicated header remote controllers	Remote controller	Remote controller address setting error ---Two remote controllers are set as header in the double-remote controller control.	*
			(* The header indoor unit stops raising alarm and follower indoor units continue to operate.)	
E10	CPU-CPU communication error	Indoor	Indoor P.C. board --- Communication error between main MCU and motor microcomputer MCU	Auto-reset
E18	Header indoor unit-indoor follower unit regular communication error	Indoor	Indoor P.C. board --- Regular communication is not possible between header and follower indoor units or between twin header (main) and follower (sub) units.	Auto-reset
E31	IPDU communication error	Outdoor	Communication error between IPDU and CDB	Entire stop
F01	Indoor unit heat exchanger sensor (TCJ) error	Indoor	Heat exchanger sensor (TCJ) , indoor P.C. board --- Open-circuit or short-circuit of the heat exchanger sensor (TCJ) was detected.	Auto-reset
F02	Indoor unit heat exchanger sensor (TC) error	Indoor	Heat exchanger sensor (TC), indoor P.C. board --- Open-circuit or short-circuit of the heat exchanger sensor (TC) was detected.	Auto-reset
F04	Outdoor unit discharge temp. sensor (TD) error	Outdoor	Outdoor temp. sensor (TD), outdoor P.C. board --- Open-circuit or short-circuit of the discharge temp. sensor was detected.	Entire stop
F06	Outdoor unit temp. sensor (TE/TS) error	Outdoor	Outdoor temp. sensors (TE/TS), outdoor P.C. board --- Open-circuit or short-circuit of the heat exchanger temp. sensor was detected.	Entire stop
F07	TL sensor error	Outdoor	TL sensor may be displaced, disconnected or short-circuited.	Entire stop
F08	Outdoor unit outside air temp. sensor error	Outdoor	Outdoor temp. sensor (TO), outdoor P.C. board --- Open-circuit or short-circuit of the outdoor air temp. sensor was detected.	Operation continued
F10	Indoor unit room temp. sensor (TA) error	Indoor	Room temp. sensor (TA), indoor P.C. board --- Open-circuit or short-circuit of the room temp. sensor (TA) was detected.	Auto-reset
F12	TS (1) sensor error	Outdoor	TS (1) sensor may be displaced, disconnected or short-circuited.	Entire stop
F13	Heat sink sensor error	Outdoor	Abnormal temperature was detected by the temp. sensor of the IGBT heat sink.	Entire stop
F15	Temp. sensor connection error	Outdoor	Temp. sensor (TE/TS) may be connected incorrectly.	Entire stop
F29	Indoor unit, other P.C. board error	Indoor	Indoor P.C. board --- EEPROM error	Auto-reset
F31	Outdoor unit P.C. board	Outdoor	Outdoor P.C. board ---- In the case of EEPROM error.	Entire stop
H01	Outdoor unit compressor breakdown	Outdoor	Current detect circuit, power voltage --- Minimum frequency was reached in the current releasing control or short-circuit current (Idc) after direct excitation was detected	Entire stop
H02	Outdoor unit compressor lock	Outdoor	Compressor circuit --- Compressor lock was detected.	Entire stop
H03	Outdoor unit current detect circuit error	Outdoor	Current detect circuit, outdoor unit P.C. board --- Abnormal current was detected in AC-CT or a phase loss was detected.	Entire stop
H04	Case thermostat operation (1)	Outdoor	Malfunction of the case thermostat	Entire stop

Indication	Main defective parts	Judging device	Parts to be checked / error description	Air conditioner status
H06	Outdoor unit low-pressure system error	Outdoor	Current, high-pressure switch circuit, outdoor P.C. board --- Ps pressure sensor error was detected or low-pressure protective operation was activated.	Entire stop
L03	Duplicated header indoor units ★	Indoor	Indoor address setting error --- There are two or more header units in the group.	Entire stop
L07	Group line in individual indoor unit ★	Indoor	Indoor address setting error --- There is at least one group-connected indoor unit among individual indoor units.	Entire stop
L08	Indoor group address not set ★	Indoor	Indoor address setting error --- Indoor address group has not been set.	Entire stop
L09	Indoor power level not set	Indoor	Indoor power level has not been set.	Entire stop
L10	Outdoor unit P.C. board	Outdoor	In the case of outdoor P.C. board setting error jumper wire (for service)	Entire stop
L20	LAN communication error	Network adapter central control	Address setting, central control remote controller, network adapter --- Duplication of address in central control communication	Auto-reset
L29	Other outdoor unit error	Outdoor	Other outdoor unit error	Entire stop
			1) Communication error between IPDU MCU and CDB MCU 2) Abnormal temperature was detected by the heat sink temp. sensor in IGBT.	Entire stop
L30	Abnormal external input into indoor unit (interlock)	Indoor	External devices, outdoor unit P.C. board --- Abnormal stop due to incorrect external input into CN80	Entire stop
L31	Phase sequence error, etc.	Outdoor	Power supply phase sequence, outdoor unit P.C. board --- Abnormal phase sequence of the 3-phase power supply	Operation continued (thermostat OFF)
P01	Indoor unit fan error	Indoor	Indoor fan motor, indoor P.C. board --- Indoor AC fan error (fan motor thermal relay activated) was detected.	Entire stop
P03	Outdoor unit discharge temp. error	Outdoor	An error was detected in the discharge temp. releasing control.	Entire stop
P04	Outdoor unit high-pressure system error	Outdoor	High-pressure switch --- The IOL was activated or an error was detected in the high-pressure releasing control using the TE.	Entire stop
P05	Open phase detected	Outdoor	The power cable may be connected incorrectly. Check open phase and voltages of the power supply.	Entire stop
P07	Heat sink overheat	Outdoor	Abnormal temperature was detected by the temp. sensor of the IGBT heat sink.	Entire stop
P10	Indoor unit water overflow detected	Indoor	Drain pipe, clogging of drainage, float switch circuit, indoor P.C. board --- Drainage is out of order or the float switch was activated.	Entire stop
P15	Gas leakage detected	Outdoor	There may be gas leakage from the pipe or connecting part. Check for gas leakage.	Entire stop
P19	4-way valve error	Outdoor (Indoor)	4-way valve, indoor temp. sensors (TC/TCJ) --- An error was detected due to temperature drop of the indoor unit heat exchanger sensor when heating.	Auto-reset (Auto-reset)
P20	High-pressure protective operation	Outdoor	High-pressure protection.	Entire stop
P22	Outdoor unit fan error	Outdoor	Outdoor unit fan motor, outdoor unit P.C. board --- An error (over current, locking, etc.) was detected in the outdoor unit fan drive circuit.	Entire stop
P26	Outdoor unit inverter Idc activated	Outdoor	IGBT, outdoor unit P.C. board, inverter wiring, compressor --- Short-circuit protection for compressor drive circuit devices (G-Tr/IGBT) was activated.	Entire stop
P29	Outdoor unit position error	Outdoor	Outdoor unit P.C. board, high-pressure switch --- Compressor motor position error was detected.	Entire stop
P31	Other indoor unit error	Indoor	Another indoor unit in the group is raising an alarm.	Entire stop
			E03/L07/L03/L08 alarm check locations and error description.	Auto-reset

★ The air conditioner automatically enters the auto-address setting mode.

### ▼ Common Check Codes

- L09** **Indoor unit Power Code incorrect**  
Check the settings of DN Code 11 (see Page 10).
- L30** **Fan Motor operation monitor**  
Entire Stop. Check the operation monitoring of the EC fan motors. If this contact is "CLOSED", the error message "L30" is generated.

## 8 MAINTENANCE GUIDELINES

### Maintenance interval

The maintenance of the units should be carried out before the heating period, to ensure correct functioning of the air curtain.

### Cleaning interval

The cleaning of the inlet grilles depends on the contamination of the unit. It is recommended to clean it every 3-6 weeks.

### Casing

External staining on the unit doesn't have an impact on the functioning of the air curtain. For esthetical reasons we recommend to clean the casing with a damp cloth and a mild cleaning detergent.

### Inlet grille (filter)

The units are designed for easy cleaning and servicing. It is not necessary to disassemble the unit to clean the inlet grille. All dust can be removed with a Hoover and a brush. It can also be cleaned with a damp cloth.

Please let the inlet grille dry before restarting the unit!

### Heat exchanger

To open the access panel, please remove the inlet grille first by opening the clip fixings with a flat screw driver. Security ropes prevent the grilles to fall down. The access panel is provided with a security screw that can be removed after the inlet grille has been detached. Please be careful when removing access panel and outlet grille.

For security reasons the unit has to be taken off the electrical power supply.

The R410A DX Coil has to be cleaned with a Hoover and a brush behind the inlet grille.

The fans or motors are low maintenance. All motors are long-term lubricated and do not need special maintenance. Only check that the fans run freely and the fixing points are in order.

### Recycling

It is possible to recycle air curtains.

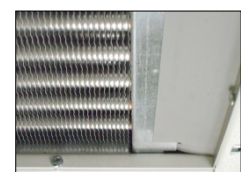



## 9 OPTIONAL PARTS

### ▼ Remote controllers

<b>RBC-AMT32E</b>	Wired remote controller
<b>TCB-EXS21TLE</b>	Schedule and Weekly Timer accessory
<b>RBC-AS21E2</b>	Simplified wired remote controller for domestic and hotel application
<b>RBC-AMS41E</b>	Wired remote controller with weekly timer
<b>RBC-AMS51E</b>	Lite-Vision plus remote controller
<b>TCB-AX32E2</b>	Wireless remote controller and receiver



RBC-AMT32E

TCB-EXS21TLE

RBC-AS21E2

RBC-AMS41E

RBC-AMS51E

TCB-AX32E2

### ▼ TCB-PCNT30TLE2 TCC Link connection interface

The electrical box in the DX Air Curtain is pre-drilled to accommodate this option accessory.

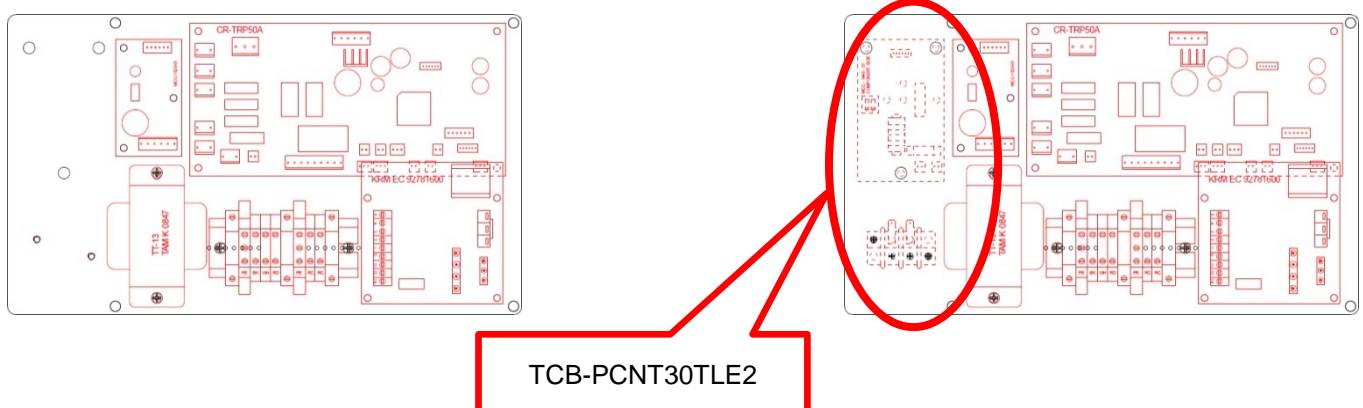

TCB-PCNT30TLE2

# 10 TECHNICAL SPECIFICATIONS

MODEL CODE	MODEL DESCRIPTION	OUTDOOR SIZING	HEATING OUTPUT	SDI4 COP (AT)	SDI4 COP (AT8)	DI3 COP	DI4 COP	AIR FLOW RATE	POWER INPUT FAN ONLY	DOOR WIDTH	MAX DOOR HEIGHT	UNIT HEIGHT	UNIT WIDTH	UNIT DEPTH	UNIT WEIGHT	SOUND PRESSURE
		hp	kW	(AT)	(AT8)			m <sup>3</sup> /h	kW	mm	m	mm	mm	mm	kg	dBa
RAV-CT101BH-M	1.0m Air Curtain Built-in	3.0	8.0 / 7.7 (DI4)	3.06	n/a	2.83	2.83	1600	0.35	1000	3.0	405-485	1105	720	71	54
RAV-CT101BH-L	1.0m Air Curtain Built-in	3.0	8.0 / 7.7 (DI4)	3.09	n/a	2.84	2.84	2210	0.53	1000	3.2	405-485	1105	720	74	55
RAV-CT101CH-M	1.0m Air Curtain Free-Hanging	3.0	8.0 / 7.7 (DI4)	3.06	n/a	2.83	2.83	1600	0.35	1000	3.0	260	1210	490	48	54
RAV-CT101CH-L	1.0m Air Curtain Free-Hanging	3.0	8.0 / 7.7 (DI4)	3.09	n/a	2.84	2.84	2210	0.53	1000	3.2	260	1210	490	51	55
RAV-CT101UH-M	1.0m Air Curtain Cassette	3.0	8.0 / 7.7 (DI4)	3.06	n/a	2.83	2.83	1600	0.35	1000	3.0	260	1050	780	40	54
RAV-CT101UH-L	1.0m Air Curtain Cassette	3.0	8.0 / 7.7 (DI4)	3.09	n/a	2.84	2.84	2210	0.53	1000	3.2	260	1050	780	43	55
RAV-CT151BH-M	1.5m Air Curtain Built-in	4.0	11.2	3.39	3.39	3.00	3.15	2400	0.53	1500	3.0	405-485	1605	720	105	55
RAV-CT151BH-L	1.5m Air Curtain Built-in	4.0	11.2	3.45	3.45	3.05	3.21	2950	0.70	1500	3.2	405-485	1605	720	108	56
RAV-CT151CH-M	1.5m Air Curtain Free-Hanging	4.0	11.2	3.39	3.39	3.00	3.15	2400	0.53	1500	3.0	260	1710	490	77	55
RAV-CT151CH-L	1.5m Air Curtain Free-Hanging	4.0	11.2	3.45	3.45	3.05	3.21	2950	0.70	1500	3.2	260	1710	490	80	56
RAV-CT151UH-M	1.5m Air Curtain Cassette	4.0	11.2	3.39	3.39	3.00	3.15	2400	0.53	1500	3.0	260	1550	780	95	55
RAV-CT151UH-L	1.5m Air Curtain Cassette	4.0	11.2	3.45	3.45	3.05	3.21	2950	0.70	1500	3.2	260	1550	780	98	56
RAV-CT201BH-M	2.0m Air Curtain Built-in	5.0	14.0 / 12.8 (DI4)	3.20	3.20	2.88	3.03	3200	0.70	2000	3.0	405-485	2105	720	129	56
RAV-CT201BH-L	2.0m Air Curtain Built-in	5.0	14.0 / 12.8 (DI4)	3.26	3.26	2.93	3.09	4420	1.05	2000	3.2	405-485	2105	720	135	57
RAV-CT201CH-M	2.0m Air Curtain Free-Hanging	5.0	14.0 / 12.8 (DI4)	3.20	3.20	2.88	3.03	3200	0.70	2000	3.0	260	2210	490	101	56
RAV-CT201CH-L	2.0m Air Curtain Free-Hanging	5.0	14.0 / 12.8 (DI4)	3.26	3.26	2.93	3.09	4420	1.05	2000	3.2	260	2210	490	107	57
RAV-CT201UH-M	2.0m Air Curtain Cassette	5.0	14.0 / 12.8 (DI4)	3.20	3.20	2.88	3.03	3200	0.70	2000	3.0	260	2050	780	99	56
RAV-CT201UH-L	2.0m Air Curtain Cassette	5.0	14.0 / 12.8 (DI4)	3.26	3.26	2.93	3.09	4420	1.05	2000	3.2	260	2050	780	105	57
RAV-CT251BH-M	2.5m Air Curtain Built-in	6.0	16.0	n/a	2.92	2.86	n/a	4000	0.88	2500	3.0	405-485	2605	720	170	57
RAV-CT251BH-L	2.5m Air Curtain Built-in	6.0	16.0	n/a	2.97	2.91	n/a	5160	1.23	2500	3.2	405-485	2605	720	176	58
RAV-CT251CH-M	2.5m Air Curtain Free-Hanging	6.0	16.0	n/a	2.92	2.86	n/a	4000	0.88	2500	3.0	260	2710	490	132	57
RAV-CT251CH-L	2.5m Air Curtain Free-Hanging	6.0	16.0	n/a	2.97	2.91	n/a	5160	1.23	2500	3.2	260	2710	490	138	58
RAV-CT251UH-M	2.5m Air Curtain Cassette	6.0	16.0	n/a	2.92	2.86	n/a	4000	0.88	2500	3.0	260	2550	780	120	57
RAV-CT251UH-L	2.5m Air Curtain Cassette	6.0	16.0	n/a	2.97	2.91	n/a	5160	1.23	2500	3.2	260	2550	780	126	58

Performance data based on rated conditions: Indoor air temperature 20°C db, Outdoor Air Temperature 7°C db / 6°C wb  
Sound Pressure Level measured at 3m.

# 11 TECHNICAL DRAWINGS

## Air Curtain Free-Hanging (CH)

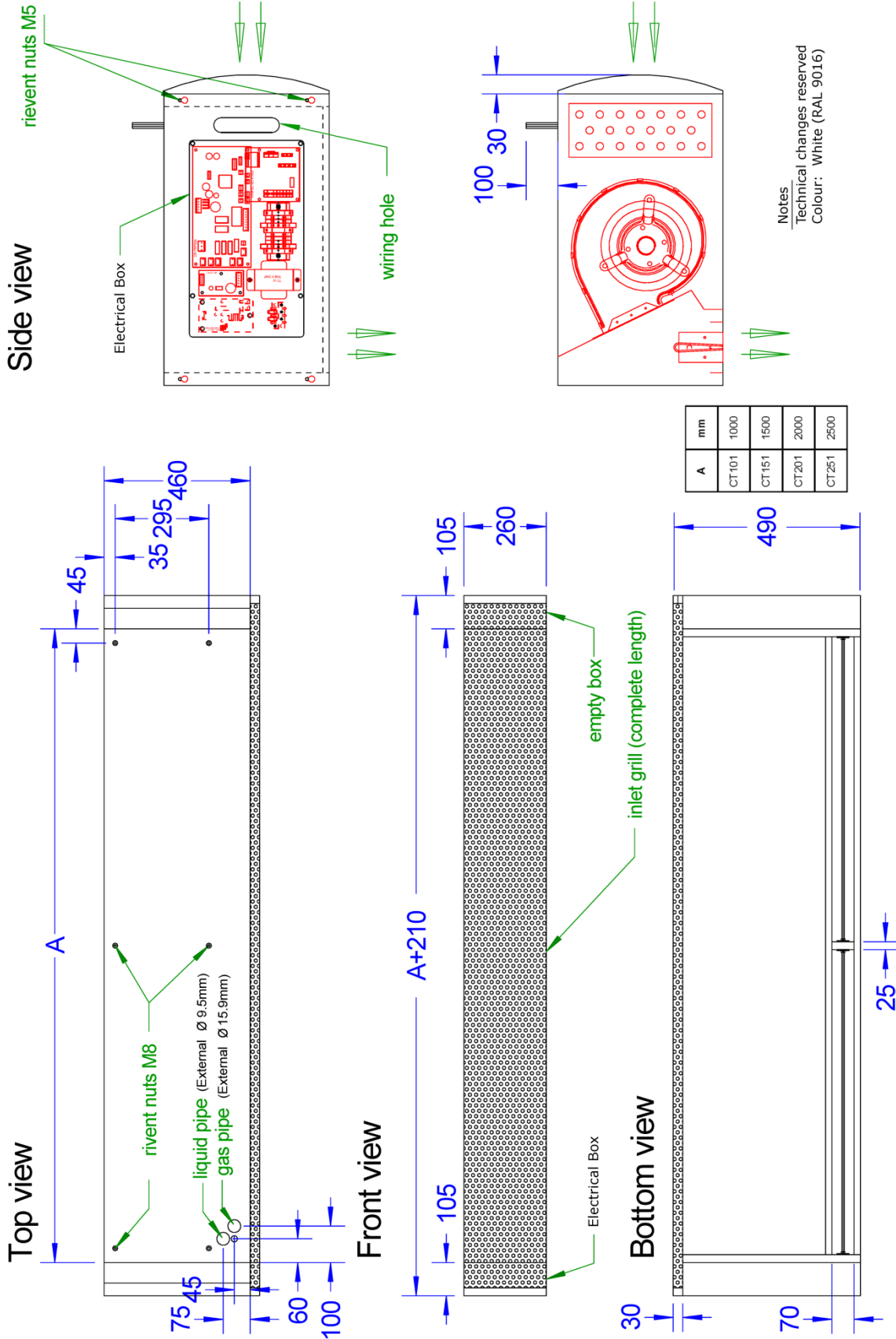

**Air Curtain Built-in (BH)**

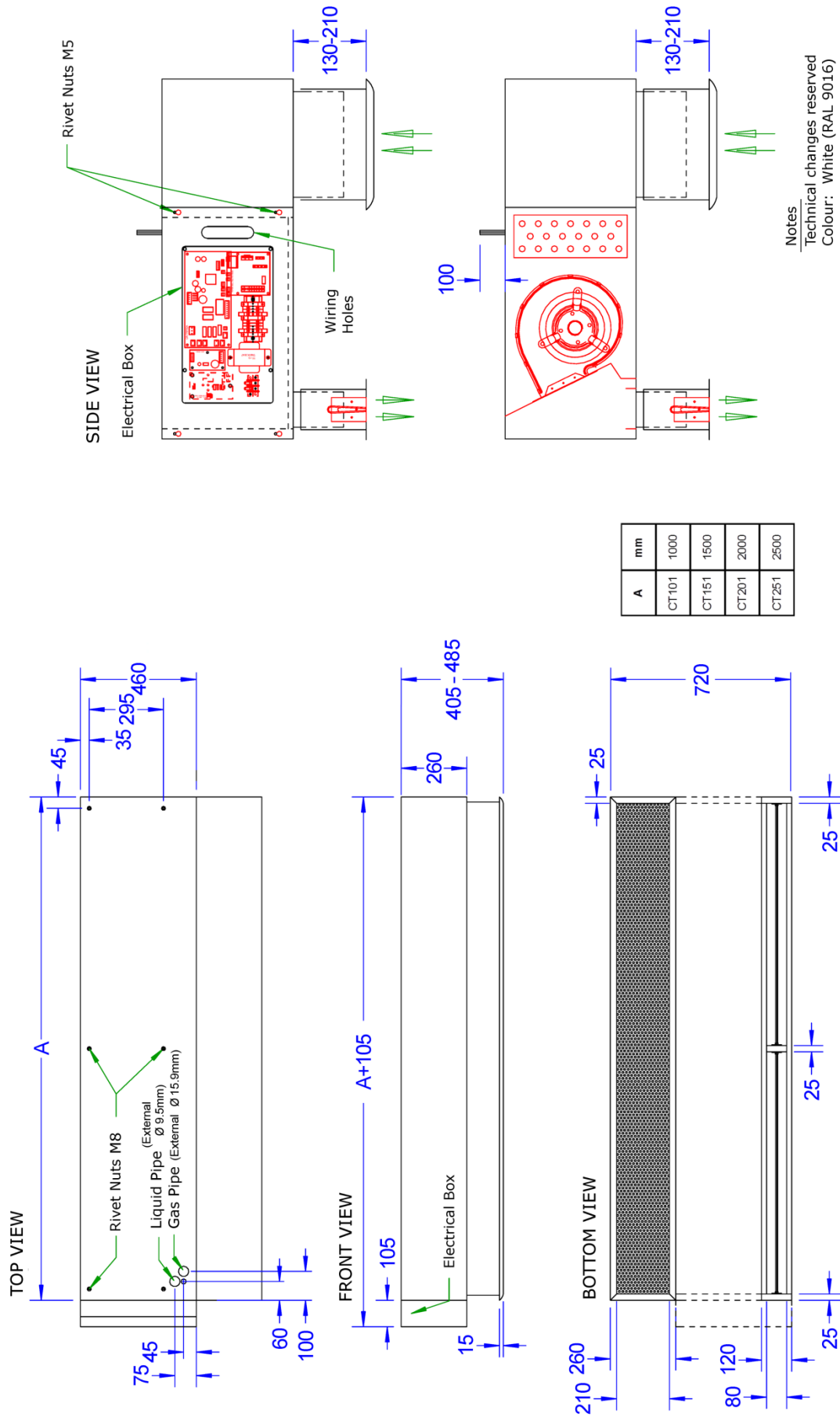

A	mm
CT101	1000
CT151	1500
CT201	2000
CT251	2500

Air Curtain Cassette (UH)

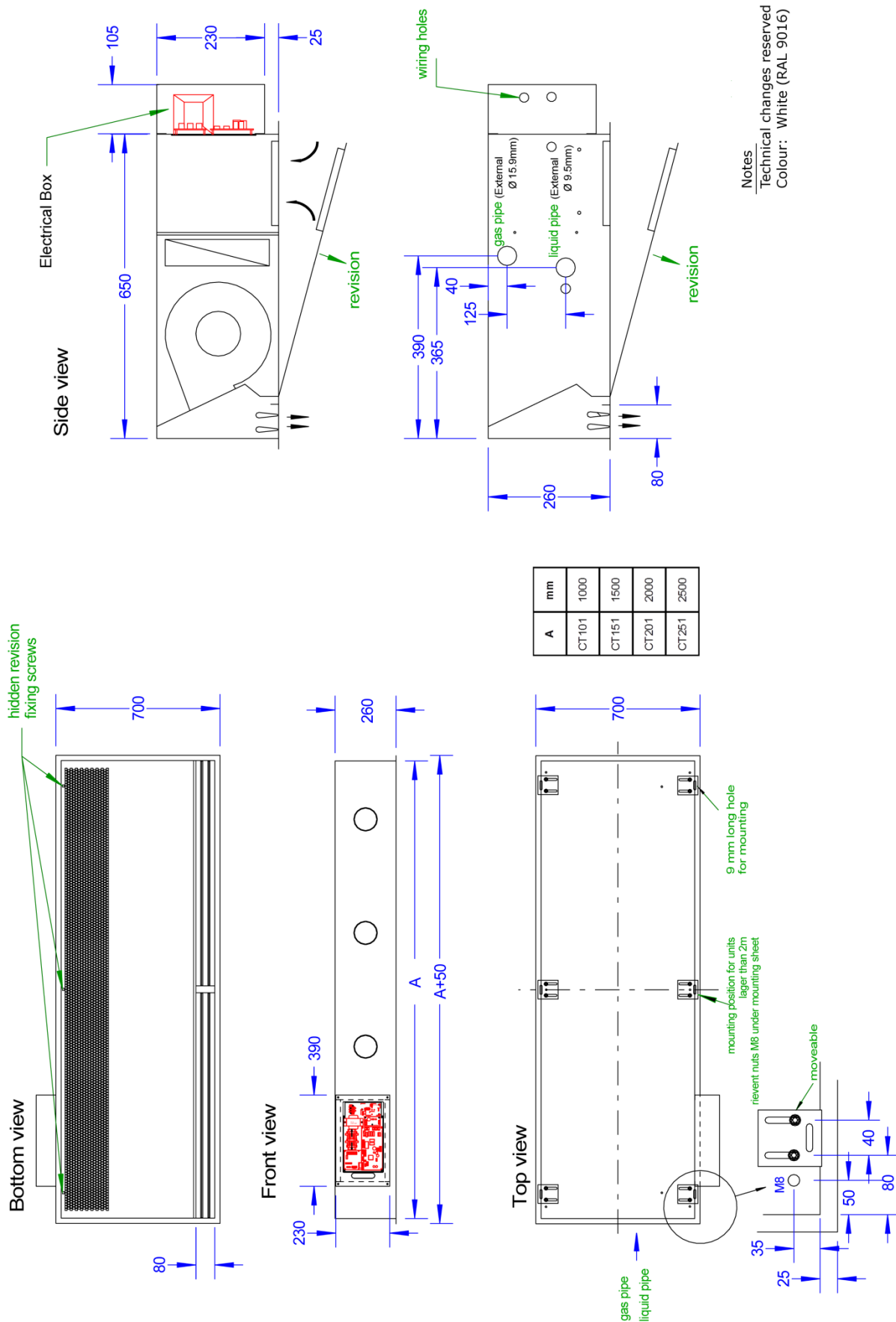

Notes  
 Technical changes reserved  
 Colour: White (RAL 9016)

A	mm
CT101	1000
CT151	1500
CT201	2000
CT251	2500

# 12 DECLARATION OF CONFORMITY

## DECLARATION OF CONFORMITY

**Manufacturer:** Lufttechnische Anlagen und Gerätebau GmbH  
Albert-Einstein-St.11  
Businesspark Galkhausen  
40764 Langenfeld  
Germany

According to the guidelines of the electromagnetic compatibility directive (2004/108/EC) and the low voltage directive (2006/95/EC) we declare that the product described below:

**Generic Denomination:** Air Conditioner

**Model/type:** RAV-CT101 / 151 / 201 / 251BH-M/L  
RAV-CT101 / 151 / 201 / 251CH-M/L  
RAV-CT101 / 151 / 201 / 251UH-M/L

**Commercial name:** DX Air Curtain (EC) Built-in (BH) / Free-Hanging (CH) / Cassette (UH)

Complies with the provisions of the following harmonized standard:

EN 50366: 2003 / A1: 2006  
EN 55014-1:2006  
EN 55014-2: 1997/A1:2001(category IV)  
EN 61000-3-2:2006, EN 61000-3-3: 1995 / A1: 2001 / A2: 2005  
EN 61000-3-11:2000, EN 61000-3-12:2005  
EN 378-2: 2008  
IEC 60335-2-40:2002 + A1 + A2  
IEC 60335-1:2001 + A1 + A2

**Note:** This declaration becomes invalid if technical or operational modifications are introduced without the manufacturer's consent.

**Signature:**



**Name:** Gregor Lipinski  
**Position:** Managing Director  
**Date:** 13.10.2014  
**Place Issued:** Germany



# 13 SERVICE PARTS

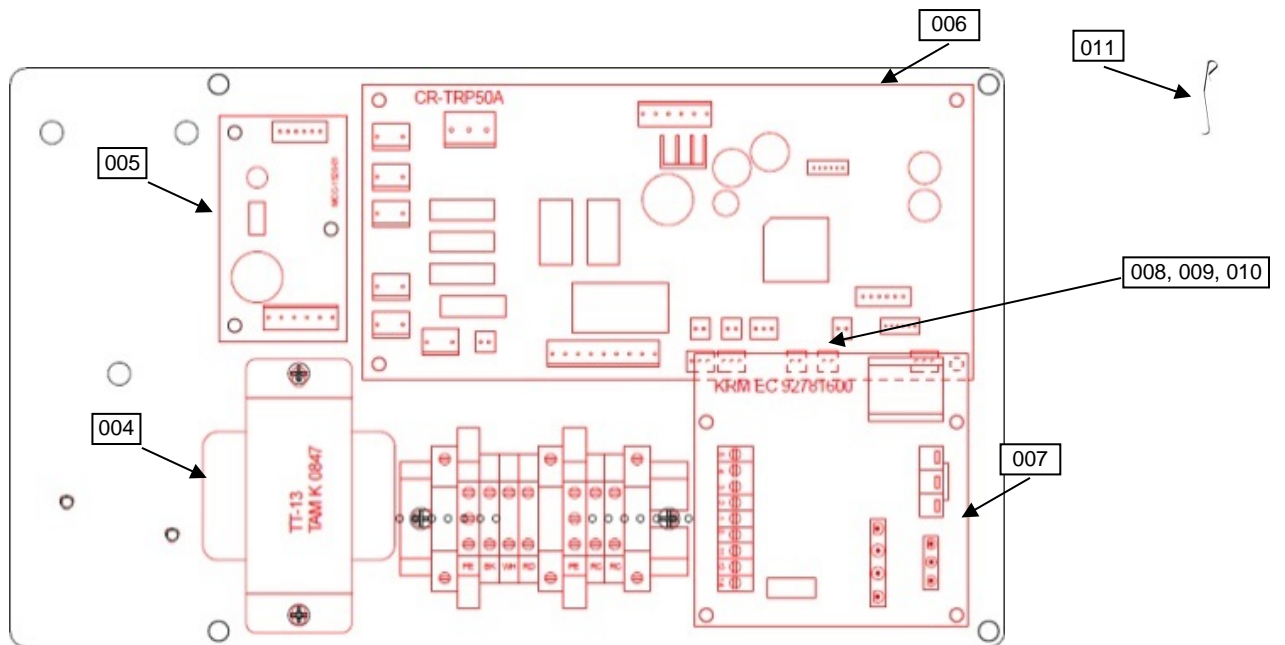

Location No.	Part No.	Description
001	8353	Fan Motor
004	43158187	Transformer
005	4316V247	Sub PCB MCC-1520-01
006	4316V418	Control PCB MCC-1403-05
007	8355	Relay module (KRM)
008	43050426	TA Sensor
009	43050425	TC Sensor
010	43050425	TCJ Sensor
011	43019904	Fix Plate Sensor

# 14 OWNER'S: PRECAUTIONS FOR SAFETY

## ⚠ WARNING

### WARNINGS ABOUT INSTALLATION

- Make sure to ask the qualified installation professional in electric work to install the air conditioner. If the air conditioner is inappropriate installed by yourself, it may cause water leak, electric shock, fire, and so on.
- Be sure to connect earth wire. (grounding work) Incomplete grounding cause an electric shock. Do not connect ground wires to gas pipes, water pipes, lightning rods or ground wires for telephone wires.
- If you install the indoor unit in a small room, take appropriate measures to prevent the refrigerant from exceeding the limit concentration even if it leaks. Consult the dealer from whom you purchased the air conditioner when you implement the measures. Accumulation of highly-concentrated refrigerant may cause an oxygen deficiency accident.
- Check whether the piping work has been properly completed. When existing pipes are used and if they are not constructed properly, the refrigerant gas may leak. Contact the installation company and confirm that the piping work has been properly completed. For details of installation of the air conditioner, refer to the Installation Manual. Use tools and piping materials for R410 only. Failure to do so or improper installation may cause a burst of pipe, resulting in injury.

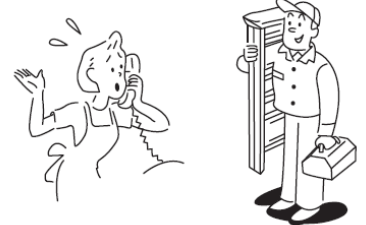

### WARNINGS ABOUT OPERATION

- Cleaning of the air filter and other parts of the discharge louver involves dangerous work in high places, so be sure to have a service person do it.
- When you notice something abnormal with the air conditioner (smells like scorching, poor heating, etc), immediately turn off the main switch, the circuit breaker, from the mains to stop the air conditioner, and contact the dealer.
- if the air conditioner is continually operated with something abnormal it may cause machine failure, electric shock, fire, and so on.

### WARNINGS ABOUT MOVEMENT AND REPAIR

- When the air conditioner cannot cool or heat a room well, contact the dealer from whom you purchased the air conditioner as refrigerant leakage is considered as the cause. In the case of repair that requires refill of refrigerant, ask service personnel about details of the repair. The refrigerant used in the air conditioner is harmless. Generally, the refrigerant does not leak. However, if the refrigerant leaks in a room and a heater or stove burner in the room catches fire, it may generate toxic gas. When you ask service personnel for repairing refrigerant leakage, confirm that the leakage portion has been completely repaired.
- Do not move or repair any unit by yourself. Since there is high voltage inside the unit, you may get electric shock when removing the cover and main unit.
- Whenever the air conditioner needs repair, make sure to ask the dealer to do it. If it is repaired imperfectly, it may cause electric shock or fire.
- When moving the air conditioner for re-installing at another place, ask the dealer to do it. If it is imperfectly installed, it may cause electric shock or fire.

## ⚠ CAUTION

### TO DISCONNECT THE APPLIANCE FROM THE MAINS SUPPLY

- This appliance must be connected to the mains by means of a switch with a contact separation of at least **3 mm**.
- **The installation fuse 40A, 25A or 16A must be used for the power supply line of this air conditioner.**

### CAUTIONS ABOUT INSTALLATION (Be sure to confirm the following cautions.)

- Use an exclusive power circuit for the air conditioner. Use the rated voltage.
- Do not install the unit in a place where inflammable gas may leak. If inflammable gas accumulates around the unit, it may cause a fire.



### CAUTIONS ABOUT OPERATION

- Carefully read this manual before starting the air conditioner. There are many important things to keep in mind for daily operation.
- Do not use this air conditioner for special purpose such as preserving food, precision instruments, art objects, breeding animals, car, vessel, etc.
- When the air conditioner is operated with a combustion appliance in the same place, be careful of ventilation to let fresh air enter the room. Poor ventilation causes oxygen shortage.
- Do not place any combustion appliance in a place where it is directly exposed to the wind of air conditioner, otherwise it may cause imperfect combustion.
- When the air conditioner is used in a closed room, be careful of sufficient ventilation of the room. Poor ventilation causes oxygen shortage.
- Do not touch any switches with wet finger, otherwise you may get an electric shock.
- If the air conditioner won't be used for a considerably long time, turn off the main switch or the circuit breaker, for safety.
- Do not put anything on the outdoor unit nor step onto it. If so, it may not only topple over the unit, but also injure yourself.
- To make the air conditioner operate in its original performance, operate it within the range of the operating temperature specified in the instructions. Otherwise it may cause a malfunction, or water leak from the unit.
- Prevent any liquid from falling into the remote controller. Do not spill juice, water or any kind of liquid.

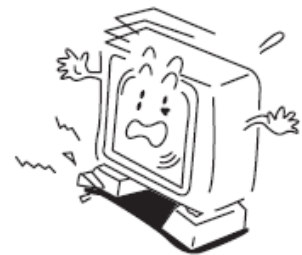

# 15 OWNER'S: REMOTE CONTROLLER INSTRUCTIONS

This remote controller can control the operation of up to 8 indoor units.

## ■ Display section

In the display example, all indicators are displayed for the explanation. In reality, only the selected contents are indicated.

- When turning on the leak breaker at the first time, **SETTING** flashes on the display part of the remote controller.
- While this display is flashing, the model is being automatically confirmed.

Accordingly, wait for a while after **SETTING** display has disappeared, and then use the remote controller.

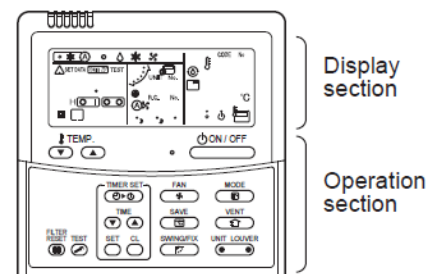

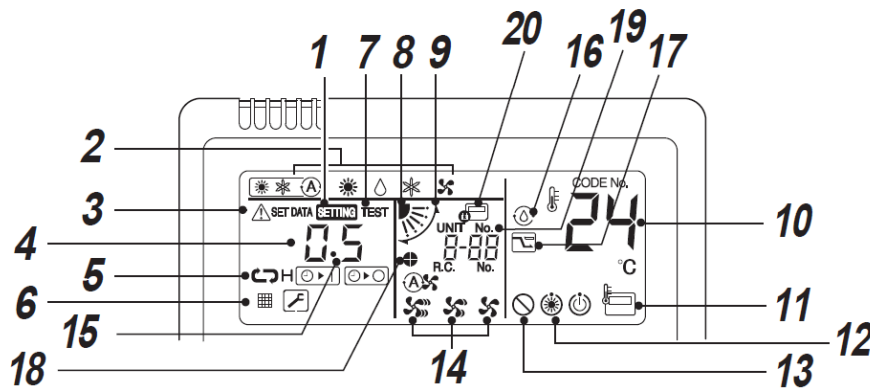



- 1 SETTING display**  
Displayed during setup of the timer etc.
- 2 Operation mode select display**  
The selected operation mode is displayed.
- 3 CHECK display**  
Displayed while the protective device works or a trouble occurs.
- 4 Timer time display**  
Time of the timer is display.  
(when a trouble occurs, the check code is displayed).
- 5 Timer SET IN setup display**  
When pushing the Timer SET IN button, the display of the timer is selected in order of [OFF] → [OFF] repeat OFF timer → [ON] → No display.
- 6 Filter display**  
If "FILTER " is displayed, clean the air filter.
- 7 TEST run display**  
Displayed during a test run.
- 8 Louver position display**  
Displays louver position.
- 9 SWING display**  
Displayed during up/down movement of the louver.
- 10 Set up temperature display**  
The selected set up temp. is displayed.
- 11 Remote controller sensor display**  
Displayed while the sensor of the remote controller is used.
- 12 PRE-HEAT display**  
Displayed when the heating operation starts or defrost operation is carried out.  
While this indication is displayed, the indoor fan stops.
- 13 No function display**  
Displayed if there is no function even if the button is pushed.
- 14 Air volume select display**  
The selected air volume mode is displayed.  
(AUTO)   
(HIGH)   
(MED.)   
(LOW)
- 15 Louver Number display.**  
(example:01, 02, 03, 04)
- 16 Dry operation in self cleaning function**  
Displayed during dry operation in self cleaning function.
- 17 Power saving mode display**  
Displayed during capacity saving mode by temporary peak-cut limiting the power current level of the outdoor unit.
- 18 Louver lock display**  
Displayed when there is a louver-locked unit in the group (including 1indoor unit by 1outdoor unit).
- 19 Unit Number display**  
Unit number of the indoor unit selected with the unit select button or abnormal indicate the indoor/outdoor unit.
- 20 Central control display**  
Displayed when the air conditioner is used under the central control in combination with a central control remote controller. In case the remote controller is disabled by the central control system, flashes. The button operation is not accepted. Even when you push ON/OFF, MODE, or TEMP. button, and the button operation is not accepted. (Settings made by the remote controller vary with the central control mode. For details, refer to the Owner's Manual of the central control remote controller.)

## Operation section

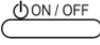
Push each button to select a desired operation.

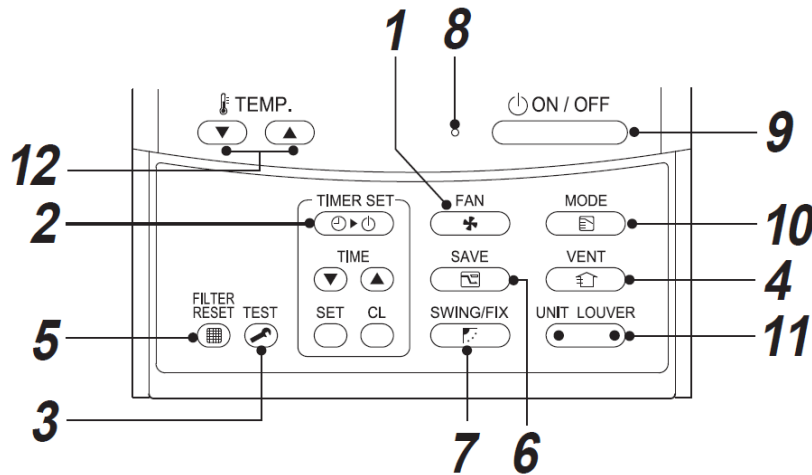
- The details of the operation needs to be set up once, afterwards, the air conditioner can be used by pushing  button only.



**1**  button (Air volume select button)  
Selects the desired air volume mode.

**2**  button (Timer set button)  
TIMER SET button is used when the timer is set up.

**3**  button (Check button)  
The Check button is used for the check operation. During normal operation, do not use this button.

**4**  button (Ventilation button)  
Ventilation button is used when a fan which is sold on the market is connected.

- If "No function"  is displayed on the remote controller when pushing the Ventilation button, a fan is not connected.

**5**  button (Filter reset button)  
Resets (Erases) "FILTER"  display.

**6**  button (Power save operation)  
SAVE button is used for power save operation.



**7**  button (Swing/Wind direction button)  
No function.

**8** Operation lamp  
Lamp is lit during operation. Lamp is off when stopped.  
Although it flashes when operating the protection device or abnormal time.

**9**  button  
When the button is pushed, the operation starts, and it stops by pushing the button again. When the operation has stopped, the operation lamp and all the displays disappear.

**10**  button (Operation select button)  
Selects desired operation mode.

**11**  Button (Unit/Louver select button)  
Select a unit number (left) and louver number (right).  
**UNIT:**  
Selects an indoor unit when adjusting wind direction when multiple indoor units are controlled with one remote controller.  
**LOUVER:**  
No function.

**12**  button (Set up temperature button)  
Adjust the room temperature.  
Set the desired set temperature by pushing  TEMP. .

### OPTIONS:

#### Remote controller sensor

Usually the TEMP.sensor of the indoor unit senses the temperature. The temperature on the surrounding of the remote controller can also be sensed.  
For details, contact the dealer from which you have purchased the air conditioner.

# 16 OWNER'S: CORRECT USAGE

- When you use the air conditioner for the first time or when you change the SET DATA value, follow the procedure below. From the next time, the operation displayed on the remote controller will start by pushing the  button only.

## Preparation

Turn on the main power switch and/or the leakage breaker.

Push each button to select a desired operation.



- When the power supply is turned on, a partition line is displayed on the display part of the remote controller.
- After the power supply is turned on, the remote controller does not accept an operation for approx. 1 minute, but it is not a failure.

### REQUIREMENT

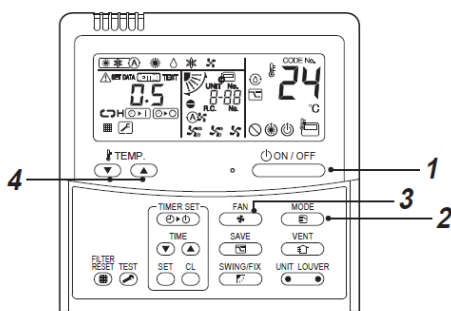
- While using the air conditioner, operate it only with  button without turning off the main power switch and the leak breaker.
- When you use the air conditioner after it has not been used for a long period, turn on the leakage breaker at least 12 hours before starting operation.









## Start

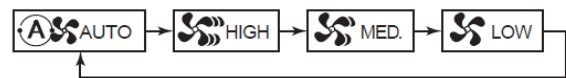

- 1 Push  button.**  
The operation lamp goes on, and the operation starts.
- 2 Select an operation mode with the "MODE  " button.**  
One push of the button, and the display changes in the order shown as follows.



- 3 Select air volume with "  " button.**  
One push of the button, and the display changes in the order shown as follows.



- When the air volume is "  " , air volume differs according to the room temperature.
- In heating operation, if the room temperature is not heated sufficiently with VOLUME "  " operation, select "  " or "  " operation.
- The temperature sensor senses temperature near the suction air port of the indoor unit, which differs from the room temperature depending on the installation condition.  
A value of setting temperature is the measure of room temperature.  
( "  " is not selectable in the FAN mode).

- 4 Determine the set up temperature by pushing the  or  button.**

## Stop

- Push  button.  
The operation lamp goes off, and the operation stops.



**In case of heating**

- The heating operation mode is selected in accordance with the room temperature and operation starts after approximately 3 to 5 minutes.
- After the heating operation has stopped, FAN operation may continue for approx. 30 seconds.
- When the room temperature reaches the set temperature and the outdoor unit stops, low fan speed is discharged and the air volume decreases.

**REQUIREMENT****When restarting the operation after stop**

- When restarting the operation immediately after stop, the air conditioner does not operate for approx. 3minutes to protect the machine.

## ■ Recommendation for Winter and Summer Operation

The outlet grille can be manually adjusted to 5 different positions. In winter the outlet grille needs to be adjusted outwards (Heating), in summer inwards (Fan Only). The airstreams then needs to be adjusted in a way that the air stream reaches the ground at room temperature.

**Winter**

- Outlet Grille Angled Outwards
- Air Curtain: HEATING
- Air Conditioning: HEATING

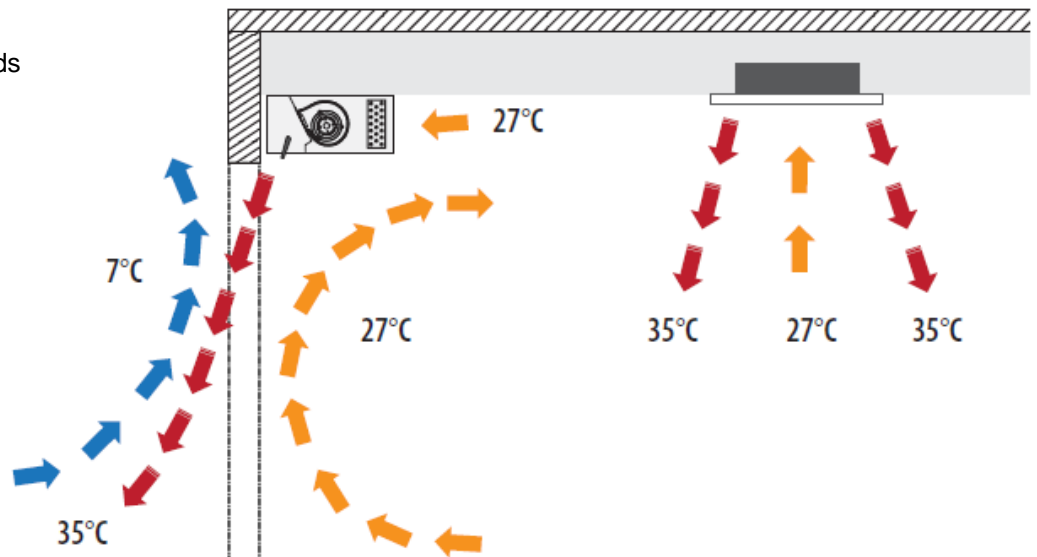
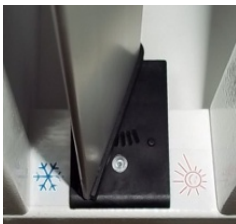
**Summer**

- Outlet Grille Angled Inwards
- Air Curtain: FAN ONLY
- Air Conditioning: COOLING

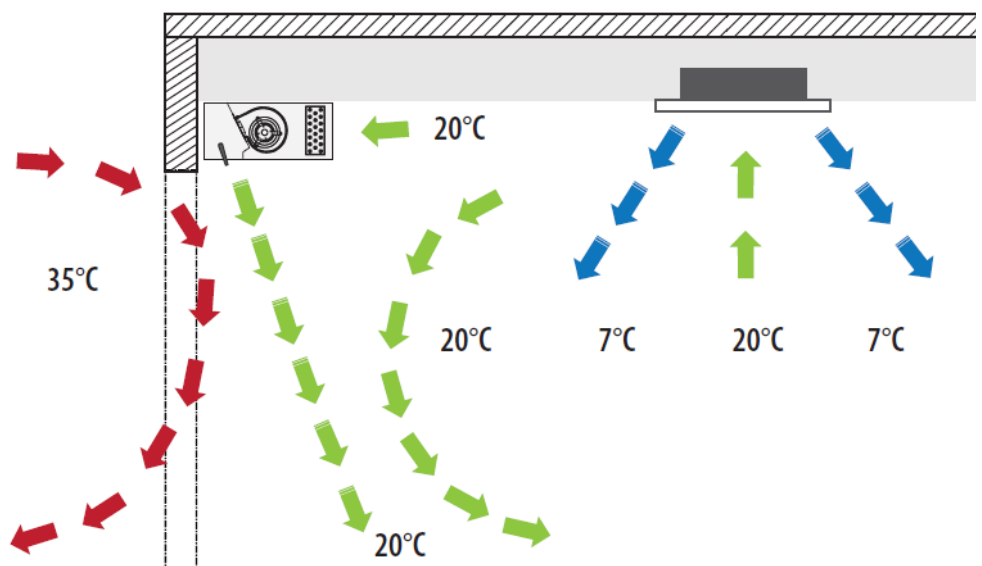

# 17 OWNER'S: TIMER OPERATION

A type of timer operation can be selected from the following three types. (Setting of up to 168hours is enabled.)

- OFF timer: The operation stops when the time of timer has reached the set time.
- Repeat OFF timer: Every time, the operation stops after the set time has passed.
- ON Timer: The operation starts when the time of timer has reached the set time.

## Timer operation

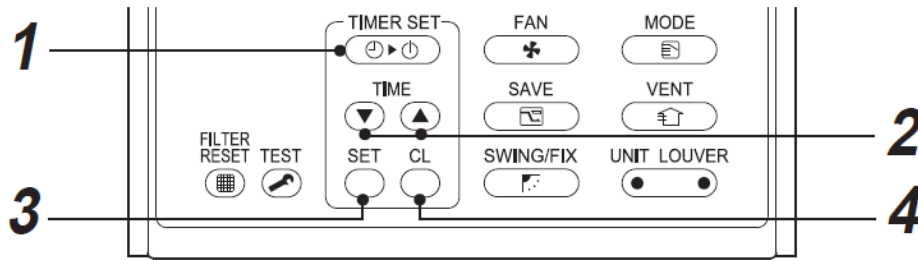

### Set

- 1 Push TIMER SET button.**  
The timer display (type) changes for every push of the button.

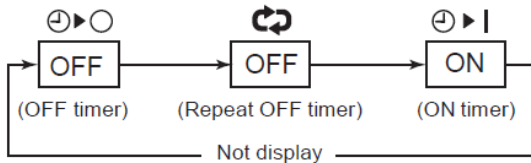

- **SETTING** and timer time display flash.

- 2 Push <sup>TIME</sup>  $\downarrow$   $\uparrow$  to select "SET TIME".**
  - For every push of  $\uparrow$  button, the set time increases in the unit of 0.5hr (30minutes). When setting a time more than 24hours for timer operation, timer time can be set in the unit of 1hr.  
The maximum set time is 168hr (7days).The remote controller displays the set time with time (between 0.5 and 23.5 hours) (\*1) or number of days and time (24 hours or more) (\*2) as shown across.

- For every push of  $\downarrow$  button, the set time decreases in the unit of 0.5hr (30minutes) (0.5 to 23.5hours) or 1hr (24 to 168hours).

#### Example of remote controller display

- In the case of 23.5 hours (\*1)



- In the case of 34hours (\*2)



Number of days Time

1d Shows 1 day (24 hours)

10h Shows 10 hours. (Total 34 hours)

- 3 Push SET button.**
  - **SETTING** display disappears and timer time display goes on, and  $\leftarrow$  or  $\rightarrow$  display flashes.  
(When ON timer is activated, timer time, ON timer  $\leftarrow$  are displayed and other displays disappear.)

- 4 Cancel of timer operation**  
**Push <sup>CL</sup> button.**  
TIMER display disappears.

### NOTE

- When the operation stops after the timer reached the preset time, the Repeat OFF timer resumes the

operation by pushing  $\leftarrow$  button and stops the operation after the time of the timer has reached the set time.

- When you push <sup>SWING/FIX</sup> while the OFF timer function of the air conditioner is active, the indication of the timer function disappears and then appears again after about 5 seconds. This is due to normal processing of the remote controller.

# 18 OWNER'S: MAINTENANCE



## WARNING

Cleaning of the air filter and other parts of the air filter involves dangerous work in high places, so be sure to have a service person do it.  
Do not attempt it yourself.

### Cleaning of air filters

Clogging of air filters will reduce the cooling and heating performance.

(1) When "FILTER  appears on the remote controller, clean the air filters.

(2) When the cleaning of air filters has been completed, push  button. "FILTER  disappears.

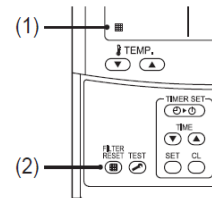

## CAUTION

### Cleaning of unit

Clean the unit with a soft dry cloth. If dirt cannot be removed with the dry cloth, use a cloth slightly dampened with lukewarm (under 40 °C) water.

### Cleaning of remote controller

- Use a dry cloth to wipe the remote controller.
- A cloth dampened with cold water may be used on the indoor unit if it is very dirty.
- Never use a damp cloth on the remote controller.
- Do not use a chemically-treated duster for wiping or leave such materials on the unit for long. It may damage or fade the surface of the unit.
- Do not use benzene, thinner, polishing powder, or similar solvents for cleaning. These may cause the plastic surface to crack or deform.

### Periodic check

Long-period use of the air conditioner may cause deterioration or failure of parts due to heat, humidity, dust, and operating conditions, or may cause poor drainage of dehumidified water.

### If you do not plan to use the unit for more than 1 month

- (1) Operate the fan for 1 or 2 hours to dry inside the unit.
  - Operate "FAN" mode.
- (2) Stop the air conditioner and turn off the main power switch or the circuit breaker.

### Checks before operation

- (1) Check that the air filters are installed.
- (2) Check that the air outlet or inlet is not blocked.
- (3) Turn on the main power switch or the circuit breaker for the main power supply to the air conditioner.



**NOTE**

- For environmental conservation, it is strongly recommended that the indoor and outdoor units of the air conditioner in use be cleaned and maintained regularly to ensure efficient operation of the air conditioner. When the air conditioner is operated for a long time, periodic maintenance (once a year) is recommended. Furthermore, regularly check the outdoor unit for rust and scratches, and remove them or apply rustproof treatment, if necessary. As a general rule, when an indoor unit is operated for 8 hours or more daily, clean the indoor unit and outdoor unit at least once every 3 months. Ask a professional for this cleaning/maintenance work. Such maintenance can extend the life of the product though it involves the owner's expense. Failure to clean the indoor and outdoor units regularly will result in poor performance, freezing, water leakage, and even compressor failure.

**Maintenance List**

<b>Part</b>	<b>Unit</b>	<b>Check (visual/auditory)</b>	<b>Maintenance</b>
Heat exchanger	Indoor / Outdoor	Dust/dirt clogging, scratches	Wash the heat exchanger when it is clogged.
Fan motor	Indoor / Outdoor	Sound	Take appropriate measures when abnormal sound is generated.
Filter	Indoor	Dust/dirt, breakage	Wash the filter with water when it is contaminated. Replace when it is damaged.
Fan	Indoor	Vibration, balance Dust/dirt, appearance	Replace the fan when vibration or balance is terrible Brush the fan when it is contaminated.
Air inlet / outlet grilles	Indoor / Outdoor	Dust/dirt, appearance	Fix or replace them when they are deformed or damaged.
Louvers	Indoor	Dust/dirt, scratches	Wash them when they are contaminated or apply repair coating.
Exterior	Outdoor	Rust, peeling of insulator Peeling/lift of coat	Apply repair coating.

# 19 OWNER'S: AIR CONDITIONER OPERATIONS AND PERFORMANCE

## 3 minutes protection function

3-minutes protection function prevents the air conditioner from starting for initial 3 minutes after the main power switch/circuit breaker is turned on for re-starting the air conditioner.

## Power failure

Power failure during operation will stop the unit completely.

- To restart the operation, push the START/STOP button on the remote controller.
- Lightning or a wireless car telephone operating nearby may cause the unit to malfunction. Turn off the main power switch or circuit breaker and then turn them on again. Push the START/STOP button on the remote controller to restart.

## Heating characteristics

### Preheating operation

The air conditioner will not deliver warm air immediately after it is turned on. Warm air will start to flow out after approximately 5 minutes when the indoor heat exchanger warmed up.

### Warm air control (In heating operation)

When the room temperature reaches the set temperature, the fan speed is automatically reduced to prevent to blow cold draft. At this time, the outdoor unit will stop.

### Defrosting operation

If the outdoor unit is frosted during the heating operation, defrosting starts automatically (for approximately 2 to 10 minutes) to maintain the heating capacity.

- The fans in both indoor and outdoor units will stop during the defrosting operation.
- During the defrosting operation, the defrosted water will be drained from the bottom plate of the outdoor unit.

### Heating capacity

In the heating operation, the heat is absorbed from the outside and brought into the room. This way of heating is called heat pump system. When the outside temperature is too low, it is recommended to use another heating apparatus in combination with the air conditioner.

### Attention to snowfall and freeze on the outdoor unit

- In snowy areas, the air inlet and air outlet of the outdoor unit are often covered with snow or frozen up. If snow or freeze on the outdoor unit is left as it is, it may cause machine failure or poor warming.
- In cold areas, pay attention to the drain hose so that it perfectly drains water without water remaining inside for freeze prevention. If water freezes in the drain hose or inside the outdoor unit, it may cause machine failure or poor warming.

### Air conditioner operating conditions

For proper performance, operate the air conditioner under the following temperature conditions:

Heating operation	Outdoor temperature	-15°C to 15°C (Wet bulb temp.)
	Room temperature	15°C to 28°C (Dry bulb temp.)

If the air conditioner is used outside of the above conditions, safety protection may work.







Toshiba Carrier (UK) Ltd  
Porsham Close  
Belliver Industrial Estate  
Plymouth  
Devon  
United Kingdom  
PL6 7DB

 +44 (0) 1752 753200

 +44 (0) 1752 753222